

FR GUIDE D'INSTALLATION ET D'UTILISATION
EN GUIDE TO INSTALLATION AND USE
PT MANUAL DE INSTALAÇÃO E UTILIZAÇÃO
ES MANUAL DE INSTALACIÓ Y UTILIZACIÓN

Table de cuisson
Cooking Hob
Placa de cozinha
Placa de cocció

De Dietrich 



FR 02

EN 16

PT 32

ES 46

Dear Customer,

You have just acquired a DE DIETRICH hob and we would like to thank you.

In order to offer you an excellent product, our research teams have created this new generation of appliances for you. Their quality, appearance, functions and technological advances make them exceptional products, showcases of our unique know-how.

In the line of DE DIETRICH products, you will also find a wide range of ovens, microwaves, ventilation hoods, hoods, dishwashers, and refrigerators, all of which can be integrated and all of which can be coordinated with your new DE DIETRICH hob.

Of course, in our ongoing desire to ensure our products satisfy your needs in the best possible way, our customer service department is always at your disposal at our site.

www.dedietrich-electromenager.com

DE DIETRICH
Setting New Values

We are constantly improving our products; for this reason we reserve the right to make all modifications to their technical, functional or aesthetic characteristics, originating from technical developments.



Warning

This product is not foreseen for sale in the USA
Before installing and using your appliance please read this installation and use the guide carefully - it will help you familiarise yourself very rapidly with its operation.

1 / INSTALLING YOUR APPLIANCE	
• Installation _____	18
• Connection _____	19
2 / USING YOUR APPLIANCE	
• The induction principle _____	21
• Description of your top _____	22
• Using a cooking zone _____	24
• Additional functions _____	24
Preheating	
<i>MEMO</i> - Memorisation of a cooking setting	
Delayed cooking	
Independent timer	
Preselected power settings	
Child safety	
Clean lock	
• Safety features when operating _____	26
3 / MAINTAINING YOUR APPLIANCE _____	27
4 / SPECIAL MESSAGES, DIFFICULTIES _____	28
5 / AFTER- SALES SERVICE _____	29



As shown in this logo, the materials used to package this appliance are not recyclable. Recycle them and play a role in protecting the environment by depositing them in municipal containers provided for this purpose.

Recycling of the appliances organised by your manufacturer will thus be undertaken in optimum conditions, in accordance with European directive 2002/96/CE relating to electrical and electronic equipment waste. Contact your local authority or retailer for how to have used appliances collected or collection points.

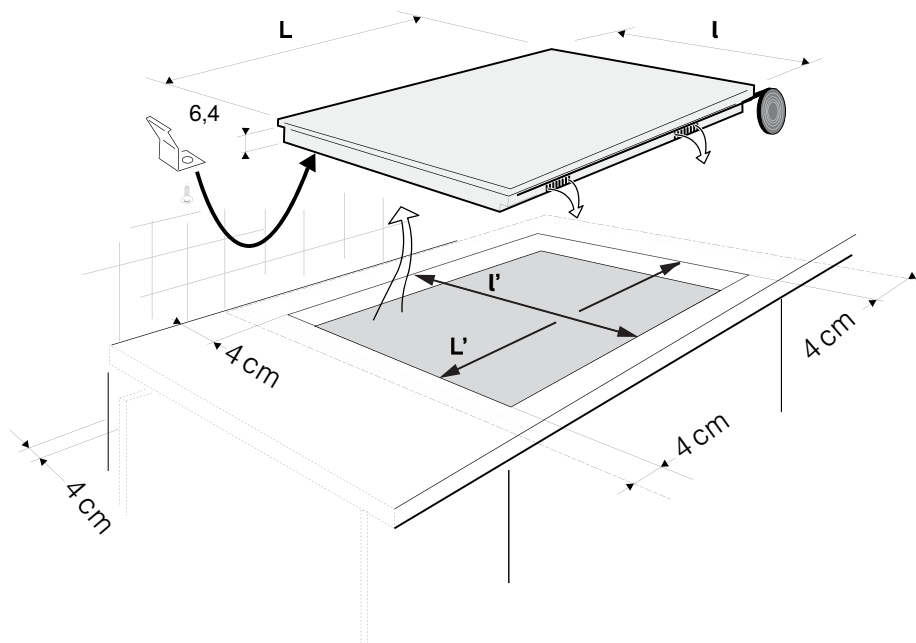

Installation

Your appliance should be positioned so that the mains switch is accessible.

The distance between the edge of your appliance and the side and rear walls (or partitions) must be at least four centimetres (area A).

Your appliance can be easily integrated above a cabinet, an oven or a build-in household appliance. Simply verify that the air intakes and outlets are well clear.

Stick the foam gasket to the bottom of your appliance. This will allow you to achieve an air-tight seal with the worktop.

Attach the clips to the hob. (See drawing)



Tip

If your hob is located above your oven, the hob's thermal safety measures forbid the simultaneous use of the hob and your oven's pyrolysis program (self-cleaning by extreme heat).

This safety feature can be activated, for example, when the hob is installed over an oven that is not sufficiently insulated. If this occurs, a series of small lines appear in the control panel. In this case, we recommend that you increase the ventilation of your hob by creating an opening in the side of your cabinet (8 cm x 5 cm) and/or that you install the oven insulation kit (reference 75X1652) that is available from the After-Sales Service Department.

Connection

These hobs must be connected to the mains using a socket in compliance with publication CEI 60083 or an all-pole circuit-breaker device in compliance with the installation rules in force.

When power is first supplied to your hob, or after an extended power cut, an indicator light will appear on the control panel. This information will disappear after 30 seconds.

• Hook-up of 220-240V ~

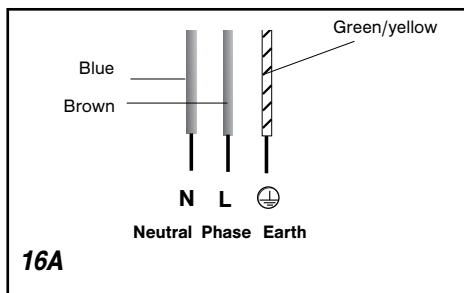
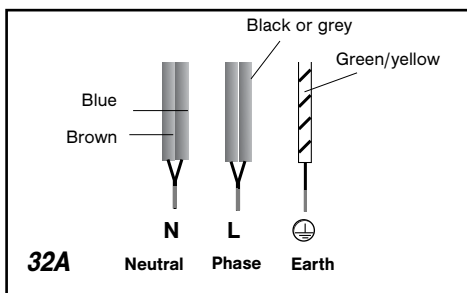

• Hook-up of 2x230V 2L+2N ~ - 16A

Separate the wires before connection.

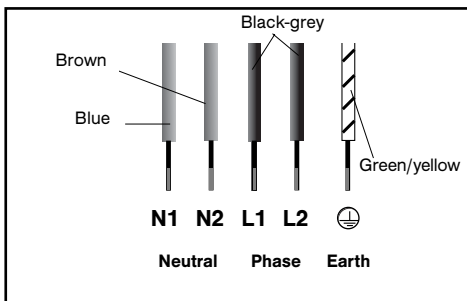

• Hook-up of 400V 2N ~ - 16A

Separate the 2 phase wires (L1 and L2) before connection.

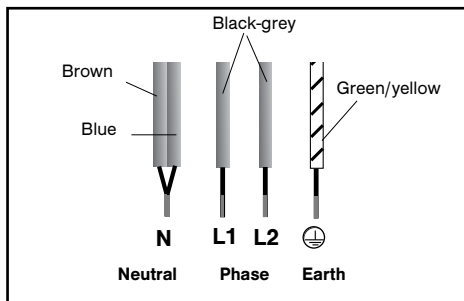

With hook-up of 400 V 2N three phase, verify that the neutral wire is properly connected.

• Hook-up of 400V 3 ~ - 16A

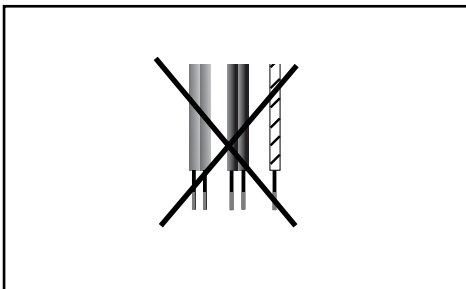

Warning

If the cable is damaged it must be replaced by the manufacturer, its after-sales service or a person with a similar qualification to prevent danger.

Connection DTI706X

• Hook-up of 220-240V ~

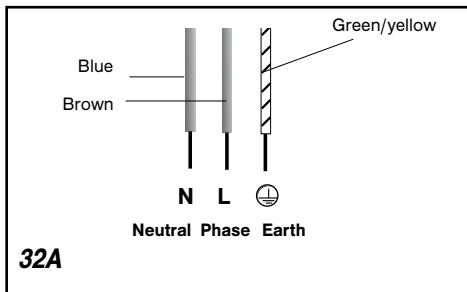
**Connection DTI709X**

• 220-240 V monophase hook-up

32 amp fuses.

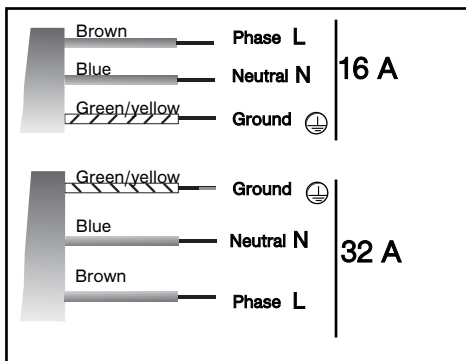

63 amp fuse.

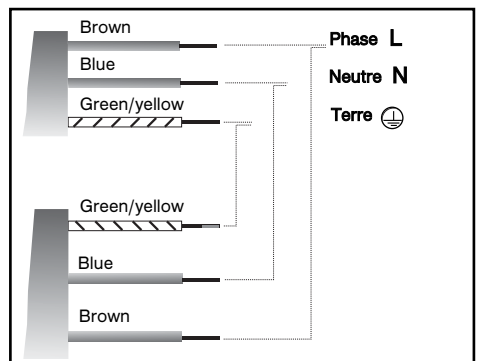
**Warning**

If the cable is damaged it must be replaced by the manufacturer, its after-sales service or a person with a similar qualification to prevent danger.

We have designed this cooking hob for use by private individuals in their homes. These cooking hobs are intended exclusively for cooking beverages and foodstuffs and do not contain any asbestos-based materials.

• *The induction principle*

The principle of induction is based on a magnetic effect.

When you place your cookware on a cooking zone and you turn it on, the electronic circuits in your cooking hob produce “induced” currents in the bottom of the cookware which instantly raise its temperature. This heat is then transmitted to the food

To help you choose, a list of cookware is provided with this guide.

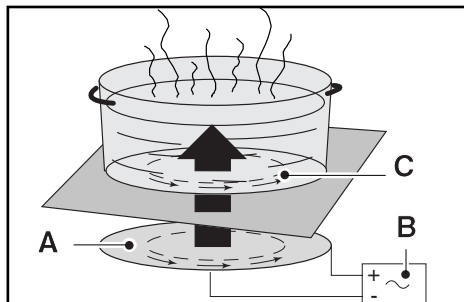

A - Induction plate

B - Electronic circuit

C - Induced currents

• *Cookware*

Most cookware is compatible with induction. To verify that your cookware is suitable, place it on a heating area on power 4.

- If the display remains on, your cookware is compatible.
- If the display flashes, your cookware cannot be used with induction cooking.

You can also use a magnet to test the cookware.

If a magnet “sticks” to the bottom of the cookware, it is compatible with induction.

Only glass, terra cotta, aluminium without a special finish on the bottom, copper and some non-magnetic stainless steels do not work with induction cooking. We recommend that you select cookware with a thick, flat bottom. When you buy your cookware, make sure that this logo is on the package; it assures you that it is compatible with induction cooking.

**CLASS
INDUCTION**

• *Choosing a cooking area*

Cooking area	Diameter of base of cookware
16 cm	10 18 cm
18 cm	12 22 cm
21 cm	1824 cm
23 cm	12 26 cm
28 cm	12 32 cm

Description of your top

DTI705

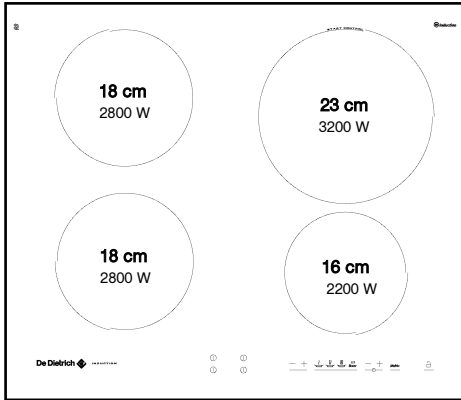
**Total dimensions (L x l) -**

DTI705B/W/X/Z : 65 x 52

DTI705V : 63 x 51

Recess cut-out (L' x l')

DTI705B/W/X/Z : 56 x 49

DTI705V : 56 x 49

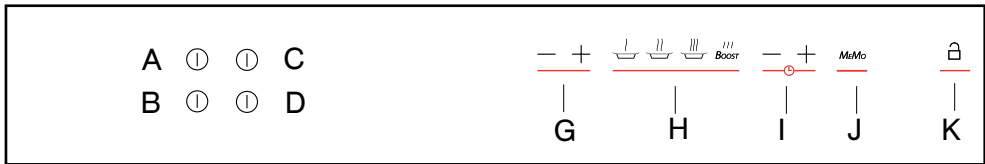
**• Adjustment touch controls**

Use these touchpads **A**, **B**, **C**, or **D** to select, turn on and turn off the cooking zones. When a zone is selected, you will see it light up, and you can adjust its settings.

For a selected zone

Indicator for selected zone Power display Timer display

• Adjustment touch controls

These touchpads allow you to adjust power, timer, programmer... for each of the selected zones.

- G** adjusting the power
- H** preselecting the power
- I** adjusting the timer
- J** *MEMO* function
- K** locking - unlocking - Clean lock

If there is no cookware on the selected zone, your adjustments will delete automatically after a few moments.

Description of your top

DTI706

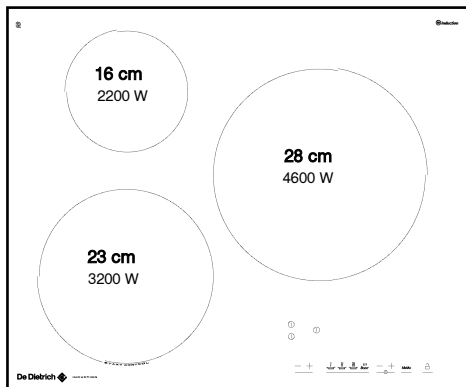

Total dimensions(L x l) -

DTI706B/X : 65 x 52

DTI706V : 63 x 51

Recess cut-out (L' x l')

DTI706B/X : 56 X 49

DTI706V : 56x49

DTI708

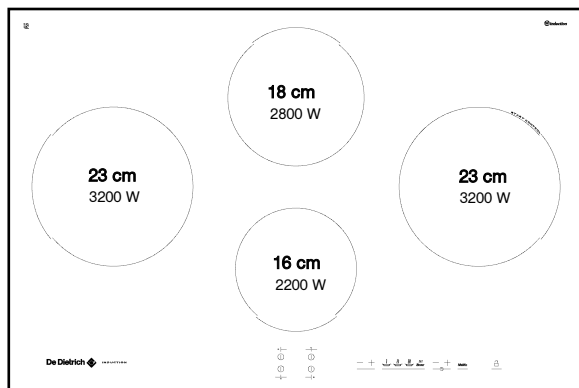

Total dimensions(L x l) -

DTI708X : 78,3 x 52

DTI708V : 77 x 51

DTI708J : 77 x 51

Recess cut-out (L' x l')

DTI708X : 75 x 49

DTI708J : 75 x 49

DTI709

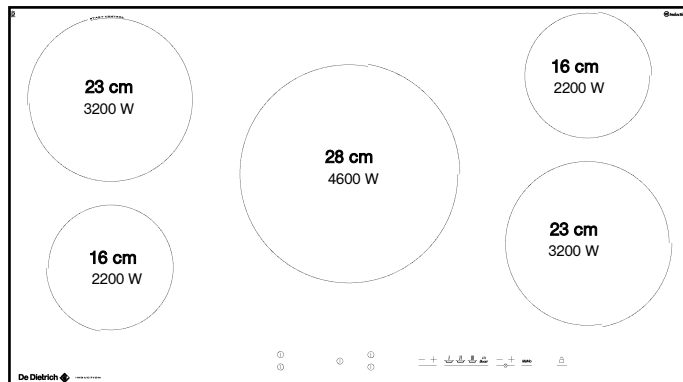

Total dimensions(L x l)





DTI709X : 93,1 x 52

DTI709J : 92,9 x 51

Recess cut-out (L' x l')

DTI709X : 90 x 49

DTI709J : 90 x 49

A   C
 B   D

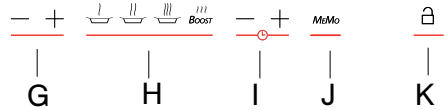

Using a cooking zone

Adjusting the power level:

- Place your cookware on the cooking zone and press the corresponding touchpad **A**, **B**, **C**, or **D**. A beep and a light will confirm your selection.
- Adjust the power with the touchpads **G**, **H**.

Cooking zone off button

- Press the select button for several seconds.

Adjusting the timer:

- Adjust the timer using touchpad **I**.
- When the cooking is finished, "0" is displayed and a beep sounds. Press on the main selector to delete this information.

N.B.:

- The first touch on **I** "-" directly selects 99 minutes.
- Simultaneous touch on **I** "+" and "-" annuls the timing in progress.
- If you do not make a selection or if there is no cookware, the selected zone turns off after a few moments.

Additional functions

• Preheating

This function allows it to reach a high temperature more rapidly, then return automatically to cooking power.

- Select a cooking zone
- Turn on preheating with the touchpad **G** "-", **HU** is displayed on your hob.
- Pre-adjust the cooking power with touchpad **G** (higher than 7). A beep confirms your adjustment after a few moments. Cooking starts.
- During the pre-heating stage, **HU** and the cooking power display alternately.
- After the pre-heating stage, your hob displays the cooking power.

N.B.:

- The pre-heating time is calculated automatically by your hob depending on the cooking power level chosen.
- When **HU** is displayed, if you do not adjust the cooking power, the zone turns off after a few moments.

• MEMO - Memorisation of a cooking setting

This function allows the hob to memorise and reproduce an entire cooking cycle.

To memorise it:

- Select a cooking zone.
- Keep your finger on the touchpad **J**, until you see it light up.
- Adjust the first power with touchpad **G**, then adjust this power to reach the time you want (minimum 10 seconds for each power setting).
- At the end of cooking, record it by keeping your finger on the touchpad of the zone.

To reproduce the cooking cycle:

- Select the same cooking zone (if the zone is different, **NO** will light up on your hob).
- Press on touchpad **J**, and the different memorised power levels will appear in a few moments. When the power indicator stops flashing, the cooking starts.

N.B.:

- Every memorisation deletes the previous one.
- Only 5 different cycles can be memorised per cycle. If you go beyond that, **NO** will display on your hob.
- In order to accurately reproduce the memorised cycle, we recommend that you always use the same cookware.
- The pre-heating function is not available in "MEMO" mode
- If your hob is off, touching the button **J** will display the memorised power settings on the corresponding display.

A ① ① C
B ① ① D

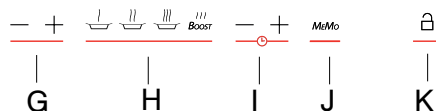

• Delayed cooking

This function allows you to delay your cooking (the cooking zone marked "Start Control").

Program delayed cooking in 6 steps:

- 1 - Select the cooking zone dedicated to this function.
- 2 - Press simultaneously on touchpads **I** "+" and "-" to adjust the current time of your hob. When the numbers flash, you can adjust the hour with the touchpad **I**, then wait a few moments. If the hour displayed is correct, wait a few moments. The display will stop flashing and a beep will confirm the setting.
- 3 - Set the end of cooking time by pressing on touchpad **I**. Wait a few moments. A beep will confirm your setting.
- 4 - Set the duration of cooking time by pressing on touchpad **I**. Wait a few moments. A beep will confirm your setting.
- 5 - Set the power of your cooking by pressing on touchpad **G**, 4 is displayed by default (maximum 6). Wait a few moments. A beep will confirm your setting and **SC** is displayed on your hob.
- 6 - After a few moments, **SC** goes out and a flashing point appears to indicate that delayed cooking has been engaged.

• Independent timer

This function allows you to time an event, without cooking.

- Select a cooking zone you are not using.
- Set the time with touchpad **I**. A "t" flashes in the display.
- At the end of your adjustment "t" becomes fixed and the count begins.

Note:

You can stop a count in progress by keeping your finger on the touchpad of the selection on the display.

• Preselected power settings

This function allows you to modify the power levels defined in the preselections (except for the boost).

- Your cooking hob must be turned off.
- Select the preselection **H** to modify, by keeping your finger on it.
- Set the new power setting by pressing on touchpad **G**.
- A beep will confirm your action after a few moments.

N.B.:

The power levels must be between:

- 1 and 5 for the first touch (4 by defect).
- 6 and 10 for the second (8 by defect)
- 11 and 15 for the third (15 by defect).

• Child safety

This function allows you to lock your hob when it is shut off or when it is cooking.

To lock:

- Keep your finger on touchpad **K**. A beep sounds and an indicator appears. The indicator will go out automatically after a few moments.

To unlock:

- Keep your finger on touchpad **K**. A beep sounds and the indicator goes out.

Note:

- In locked mode, any action will produce a key symbol on the display. You must unlock your hob before using it.
- If you activate the lock while cooking, the stop display will be prioritised on the lock.

• **Clean lock**

This function allows you to temporarily lock your hob while cleaning.

To activate Clean lock:

- Your cooking hob must be turned off.
- Briefly press touchpad **K**. A beep sounds and an indicator appears.
- After a predefined time, the lock will automatically disengage. A beep sounds and the indicator goes out.

Safety when operating

• **Residual heat**

After a long cooking period, the zone used can remain hot for several minutes. An “**H**” flashes during this period. Do not put your hand on the zone.

• **Temperature limiter**

Each cooking zone is equipped with a safety sensor that constantly monitors the temperature of the bottom of the cookware. If you leave empty cookware on a zone which is turned on, it will automatically limit the power in order to prevent damage to the cookware or hob.

• **Protection against overflows**

In case of overflow, or of a metallic object or wet cloth placed on the control areas, the hob turns itself off, the displays light up and a beep sounds. Clean the hob or remove the object, then begin cooking again.

• **Auto-Stop system**

If you forget cooking is in progress, after a predefined time, this safety function will automatically turn off your hob (from 1 to 10 hours depending on the power setting). “**AS**” displays and a beep sounds after about 2 minutes. Press on the main selector to delete this information. A beep will confirm your setting.

• **“Small Items” safety**

If you place a small object on the area (a ring, a fork, etc), the hob will detect it and not deliver any power. The power display flashes.

Note:

However, several small objects at the same time on a zone could be identified as cookware. In that case, power will be delivered by the hob.



Do not place any utensils (spoons, forks, covers, etc) on the cooking zone being used. They will heat up in the same way as cookware:

Risk of combustion.

• **For users with heart pacemakers and active implants.**

The functioning of the hob conforms to current electromagnetic interference standards and thus is in total compliance with legal requirements (89/336/EEC directives).

In order to avoid interference between your cooking hob and a pacemaker, your pacemaker must be designed and programmed in compliance with the regulations that apply to it.

As we can guarantee the compliance only of our own products, we strongly recommend that you refer to the maker of your device or to your doctor to avoid possible incompatibilities.

Preserve your appliance

The vitroceramic glass surface is highly resistant, but not unbreakable. Here are some recommendations for increasing its lifetime:

- Avoid banging or clattering the cookware.
- Avoid putting heating covers on the hob. A suction effect may damage the vitroceramic surface.
- Do not use cookware with bottoms that are rough or dented.
- Do not use your cooking hob as a work surface.
- Never use aluminium foil or paper or aluminium scrubber to clean it. The aluminium melts and damages the top.
- Never use a steam cleaner to clean your hob.

- Never directly reheat a tin can. It will have a risk of exploding.

Aesthetic faults, as a result of mistreatment of your hob and which do not entail a lack of function, are not covered by our guarantee.

And for the safety of your kitchen, do not place cleaning items or inflammable objects or products in the kitchen furniture underneath your cooking hob.

Maintaining your appliance

TYPES OF STAINS/SPOTS	USE	WHAT TO DO?
Light.	Cleaning sponges	Thoroughly moisten the zone to be cleaned with hot water, then wipe off.
Accumulation of baked-on stains/dirt. Sugar spills, melted plastics.	Cleaning sponges Scraper for glass.	Thoroughly moisten the zone to be cleaned with hot water. Use a scraper for glass to remove the large bits, follow with the rough side of a disinfectant sponge, and then wipe off.
Rings and hard water residue.	White vinegar.	Apply warm white vinegar to the stain, let stand, then wipe with a soft cloth.
Shiny metal colourings. Weekly maintenance.	Special vitroceramic glass product.	Apply a cleaning agent for vitroceramic glass (preferable one with silicon for its protective properties) to the surface.



cream



cleaning sponge
special for delicate crockery

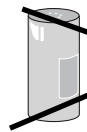

powder





abrasive sponge



• On first use

	POSSIBLE CAUSES:	WHAT SHOULD YOU DO?
A special lamp appears.	Working normally.	Nothing, the light disappears after 30 seconds.
Your installation blows a fuse.	The electrical connection of your hob is incorrect.	Check that it is set up properly. See the “Electrical Connection” section.
Only one side works.		
The hob produces an odour during the first cooking sessions.	New appliance.	Nothing. The smell will disappear after several uses.

• On switching on

YOU OBSERVE THAT:	POSSIBLE CAUSES:	WHAT SHOULD YOU DO?
The hob does not operate and the indicator lights on the control panel do not light up.	The machine is not connected to the power source. The power source or connection is defective.	Inspect the electrical circuit breaker and fuses.
The hob is not working and another message is displayed.	The electronic board is functioning poorly.	Call the After-Sales Service Department.
The hob does not function, the information   is displayed.	The hob is locked	See chapter on using the child safety system

• While in use

YOU OBSERVE THAT:	POSSIBLE CAUSES:	WHAT SHOULD YOU DO?
The hob has stopped operating and is beeping approximately every 10 seconds and a  or F7 is displayed.	There was an overflow or an object is in contact with the control panel.	Clean the hob or remove the object, then begin cooking again.
A series of small  or F7 is displayed.	The electronic circuits have overheated.	See “Inserting” section.
After turning on a heating zone, the indicator lights on the control panel continue to flash.	The cookware used is not suitable for induction or is less than 12 cm in diameter (10 cm on a 16 cm area).	See section on cookware for induction.
The saucepans make noise during cooking. Your hob makes a clicking sound during cooking.	This is normal with some types of cookware. This is caused by the transfer of energy from the hob to the cookware.	Nothing. There is no risk, neither to your hob nor to your cookware.
The fan continues to function a few minutes after your hob is turned off.	Cooling of the electronic components. Working normally.	Nothing.



In case of breakage, cracks or even light fissures in the vitroc ceramic glass, take out the fuses or turn off the circuit breaker for your hob to avoid the risk of electrical shock.

Contact the After-Sales Service Department.

In the unlikely event of there being a problem with your appliances please call the number below quoting the model number of your appliance - this can be found on the rating plate. Our trained staff are available to advise or book a service call with one of our authorized service agents.

PRODUCT WARRANTY

1. Subject to the "Statement of Standard Warranty Conditions" this product is covered by the following Warranty.

TWO (2) YEARS WARRANTY from date of purchase, covering all parts and labour.

2. The appliance is warranted under normal single family domestic installation and use, as set out in the user manual, against manufacturing defects for the Warranty periods shown above.

3. Should service be required under this Warranty, the purchaser should contact an approved DE DIETRICH Service Provider during their normal business hours.

4. At no time does DE DIETRICH have liability for any freight or transportation costs or for any damage during transit or for any consequence of failure of this appliance outside of the normal service area, unless such limitation of liability is prohibited by statute.

5. This Warranty excludes replacement of parts required due to normal wear and tear including light globes.

6. This Warranty only applies, provided the appliance has been used in accordance with the manufacturer's instructions and provided an accident, misuse, neglect or abuse has not damaged the appliance.

7. None of the above Warranties purport to exclude, restrict or modify either the application or the exercise of a right conferred by any applicable Statute.

8. Please complete the details below, which should be retained for future reference along with your proof of purchase:

Date of Purchase:

Model No:

Serial No:

Notice to Victorian Customers from the Victorian Plumbing Industry Commission.

This product must be installed by a licensed person as required by the Victorian Building Act 1993.

Only a licensed person will give you a Compliance Certificate, showing that the work complies with all the relevant standards. Only a licensed person will have insurance protecting their workmanship for 6 years. Make sure you use a licensed person to install this product and ask for your Compliance Certificate.

STATEMENT OF STANDARD WARRANTY CONDITIONS

1. The Warranty only applies provided that the appliance has been used in accordance with the manufacturer's instructions and provided that the appliance has not been damaged by an accident, misuse, neglect or abuse of any person other than the manufacturer or **MEA** or from faulty installation, mis-adjustment or tampering by unauthorised persons.

2. When a service inspection reveals the alleged fault or faults are caused by incorrect operation, contrary to the instruction manual, and otherwise the appliance is in good order and working condition, the purchaser shall be liable for a service fee charged by **MEA** or one of its' Service Providers.

3. If the appliance is used in Commercial Applications or for Rental purposes, a separate warranty of Twelve (12) months covering all parts with Three (3) months on the labour will apply.

4. Subject to the provisions of any applicable statute this Warranty applies to the original retail purchaser only and is not transferable.

5. Subject to the provisions of any applicable statute, at no time does **MEA** have liability for freight, transport or travel costs outside normal service areas.

6. None of the above Warranties purport to exclude, restrict or modify either the application or the exercise of a right conferred by any applicable statute.

7. Subject to any Warranties implied by statute, at no time will **MEA** or its' Service Providers be liable for any economic loss consequent upon the failure of the appliance.

8. This Warranty is only valid for **De Dietrich** major appliances imported and distributed by **MEA**, purchased and used in Australia.