



user manual

Tumble dryer

EDH 97981W

Electrolux. Thinking of you.

Share more of our thinking at www.electrolux.com

CONTENTS

Important safety information	2	Daily use	10
Environment	4	Drying rack	13
Installation	4	Cleaning and maintenance	14
Product description	7	What to do if ...	15
Control panel	8	Technical information	17
Before first use	8	Machine settings	17
Programme chart	9	Service	17

Subject to change without notice

IMPORTANT SAFETY INFORMATION

Important! In the interest of your safety and to ensure the correct use, before installing and first using the appliance, read this user manual carefully, including its hints and warnings. To avoid unnecessary mistakes and accidents, it is important to ensure that all people using the appliance are thoroughly familiar with its operation and safety features. Save these instructions and make sure that they remain with the appliance if it is moved or sold, so that everyone using it through its life will be properly informed on appliance use and safety.



- Please read the instruction book before using this appliance.

General safety

- It is dangerous to alter the specifications or attempt to modify this product in any way.
- This appliance is not intended for use by persons (including children) with reduced physical and sensory conditions or lack of experience and knowledge, unless they have been given supervision or instruction concerning use of the appliance by a person responsible for their safety.
- Make sure that small children and pets do not climb inside the drum. To avoid this, please check into the drum before using.
- Any objects such as coins, safety pins, nails, screws, stones or any other hard, sharp material can cause extensive damage and must not be placed into the machine.
- In order to avoid danger of fires caused by excessive drying, do not use appliance to dry the following items: Cushions, quilts etc. (these items accumulate heat).
- Items such as foam rubber (latex foam), shower caps, waterproof textiles, rubber backed articles and clothes or pillows fitted with foam rubber pads should not be dried in the tumble dryer.
- Always unplug the appliance after use, cleaning and maintenance.
- Under no circumstances should you attempt to repair the machine yourself. Repairs carried out by inexperienced persons may cause injury or serious malfunctioning. Contact your local Service Centre. Always insist on genuine spare parts.
- Items that have been soiled with substances such as cooking oil acetone, petrol, kerosene, spot removers, turpentine, waxes and wax removers should be washed in hot water with an extra amount of detergent before being dried in the tumble dryer.
- **Danger of explosion:** Never tumble dry items that have been in contact with inflammable solvents (petrol, methylated spirits, dry cleaning fluid and the like). As these substances are volatile, they could cause an explosion. Only tumble dry items washed with water.
- **Risk of fire:** items that have been spotted or soaked with vegetable or cooking

oil constitute a fire hazard and should not be placed in the tumble dryer.

- If you have washed your laundry with stain remover you must execute an extra rinse cycle before loading your tumble dryer.
- Please make sure that no gas lighters or matches have accidentally been left in pockets of garments incase they are loaded into appliance



Warning!

- **Risk of fire! Never stop a tumble dry before the end of the drying cycle unless all items are quickly removed and spread out so that the heat is dissipated.**
- **Lint must not be allowed to accumulate around the tumble dryer.**
- **Risk of electric shock!** Do not spray down the appliance with jets of water.
- The final part of a tumble dryer cycle occurs without heat (cool down cycle) to ensure that the items are left at a temperature that ensures that items will not be damaged.
- The tumble dryer is not to be used if industrial chemicals have been used for cleaning.
- Ensure you have good ventilation in the installation room to avoid the back flow of gases into the room from appliances burning other fuels, including open fires.

Installation

- This appliance is heavy. Care should be taken when moving it.
- When unpacking the appliance, check that it is not damaged. If in doubt, do not use it and contact the Service Centre.
- All packaging must be removed before use. Serious damage can occur to the product and to property if this is not adhered to. See relevant section in the user manual.
- Any electrical work required to install this appliance should be carried out by a qualified electrician or competent person.
- If the machine is situated on a carpeted floor, please adjust the feet in order to allow air to circulate freely under the appliance.

- After having installed the appliance, check that it is not pressing or standing on its electrical supply cable.
- If the tumble dryer is placed on top of a washing machine, it is compulsory to use the stacking kit (optional accessory).

Use

- This appliance is designed for domestic use. It must not be used for purposes other than those for which it was designed.
- Only wash fabrics which are designed to be machine dried. Follow the instructions on each garment label.
- Do not dry unwashed items in the tumble dryer.
- Do not overload the appliance. See the relevant section in the user manual.
- Clothes which are dripping wet should not be placed in the dryer.
- Garments which have been in contact with volatile petroleum products should not be machine dried. If volatile cleaning fluids are used, care should be taken to ensure that the fluid is removed from the garment before placing in the machine.
- Never pull the power supply cable to remove the plug from the socket; always take hold of the plug itself.
- Never use the tumble dryer if the power supply cable, the control panel, the working surface or the base are damaged so that the inside of the tumble dryer is accessible.
- Fabric softeners, or similar products should be used as specified by the fabric softener instructions.
- **Caution - hot surface** : Do not touch the door light cover surface when the light is switched on.
(Only dryers equipped with internal drum light)

Child safety

- This machine is not intended for use by young children or infirm persons without supervision.
- Children often do not recognise the hazards associated with electrical appliances. Children should be supervised to ensure that they do not play with the appliance.

**Warning!**

- Danger of suffocation! The packaging components (e.g. plastic film, polystyrene) can be dangerous to children - Keep them out of children's reach.

- Keep all detergents in a safe place out of children's reach.
- Make sure that children or pets do not climb inside the drum.

ENVIRONMENT

The symbol  on the product or on its packaging indicates that this product may not be treated as household waste. Instead it should be taken to the appropriate collection point for the recycling of electrical and electronic equipment. By ensuring this product is disposed of correctly, you will help prevent potential negative consequences for the environment and human health, which could otherwise be caused by inappropriate waste handling of this product. For more detailed information about recycling of this product, please contact your local council, your household waste disposal service or the shop where you purchased the product.

Environmental information

The packaging materials are environmentally friendly and can be recycled. The plastic components are identified by markings, e.g. >PE<, >PS<, etc. Please dispose of the packaging materials in the appropriate container at the community waste disposal facilities.

Important! The heat pump of your tumble dryer contains a closed refrigerant circuit filled with a refrigerant which is free from fluoro-chloro-hydrocarbons. The refrigerant circuit in the heat pump must not be damaged.



Warning! When a unit is no longer being used:

- Pull the plug out of the socket.
- Cut off the cable and plug and dispose of them.
- Dispose of the door catch. This prevents children from trapping themselves inside and endangering their lives.

Environmental tips

- In the dryer, laundry becomes fluffy and soft. Fabric softeners are not therefore needed when washing.
- Your dryer will function most economically if you:
 - Always keep the ventilation slots on the base of the dryer unobstructed;
 - Use the loading volumes specified in the programme overview;
 - Ensure you have good ventilation in the installation room;
 - Clean the micro-fine filter and fine strainer after each drying cycle;
 - Spin the laundry well before drying.
-  Energy consumption depends on spinning speed set in washing machine. Higher spinning speed - lower energy consumption.

INSTALLATION

Transporting the appliance

Important! Only tip the appliance on its left side to transport (see illustration), if it cannot be transported in an upright position.

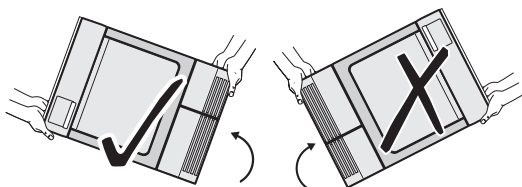

Warning! If the appliance was not transported in an upright position, leave it to stand for 12 hours before connecting it to the electricity supply and using it for the first time, so that the oil can flow back to the compressor. Otherwise the compressor could be damaged.

Appliance positioning

- It is recommended that, for your convenience, the appliance is positioned close to your washing machine.
- The tumble dryer must be installed in a clean place, where dirt does not build up.
- Air must be able to circulate freely all round the appliance. Do not obstruct the front ventilation grille or the air intake grilles at the back of the appliance.
- To keep vibration and noise to a minimum when the tumble dryer is in use, it should be placed on a firm, level surface.
- Once in its permanent operating position, check that the tumble dryer is absolutely level with the aid of a spirit level. If it is not, raise or lower the feet until it is.
- The feet must never be removed. Do not restrict the floor clearance through deep pile carpets, strips of wood or similar. This might cause heat built-up which would interfere with the operation of the appliance.

Important!

- The hot air emitted by the tumble dryer can reach temperatures of up to 60°C. The appliance must therefore not be installed on floors which are not resistant to high temperatures.
- When operating the tumble dryer, the room temperature must not be lower than +5°C and higher than +35°C, as it may affect the performance of the appliance.
- Should the appliance be moved, it must be transported vertically.
- The appliance must not be installed behind a lockable door, a sliding door a door with a hinge on the opposite side to that of the appliance in such a way that a full opening of the tumble dryer is restricted.

Removing transport safety packaging

! Caution!

Before use all parts of the transport packaging must be removed.

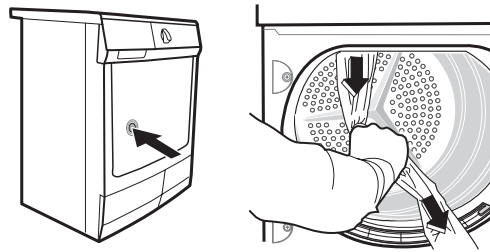

1. Open loading door
2. Pull off adhesive strips from inside machine on top of drum.
3. Remove foil hose and polystyrene padding from the machine.

Drying rack unpacking

- ! **Caution!** Before appliance use all packaging parts and drying rack must be removed from the drum. The inside of the drum must be clean.

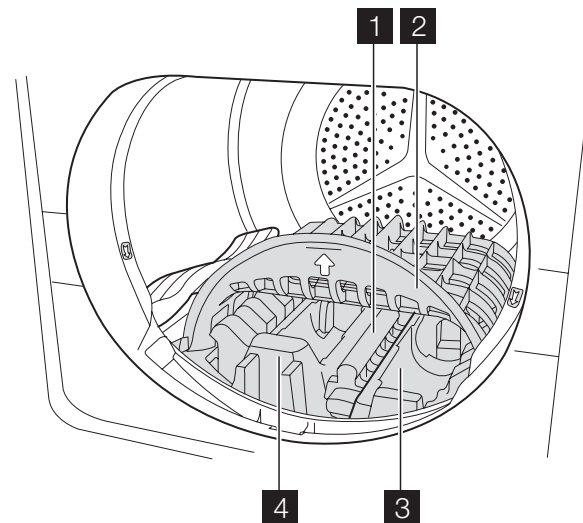

To unpack the rack:

1. Remove middle polystyrene part by pulling it.

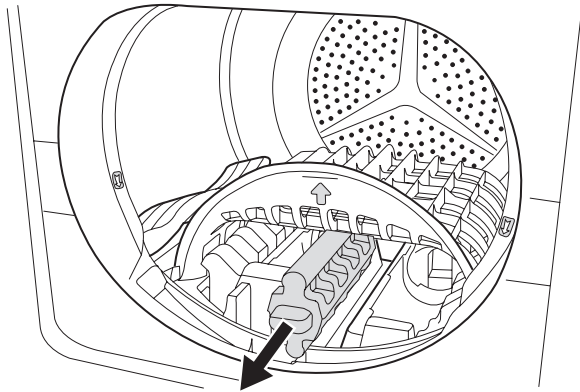

Loosen polystyrene parts 3 and 4.

3. Remove right polystyrene part by pulling it.

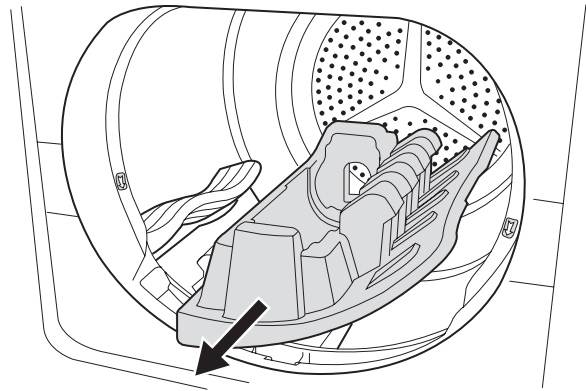

4. Remove left polystyrene part by pulling it.

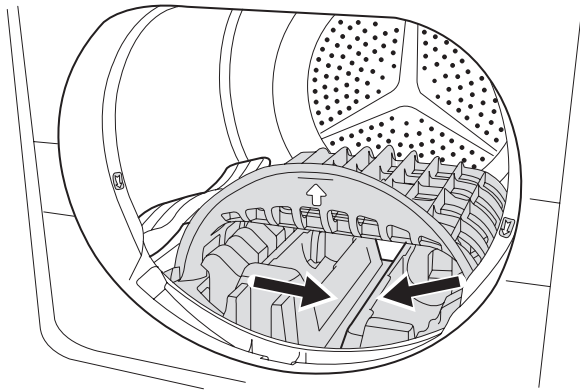

2. Lift slightly rack and take it carefully out from the drum.

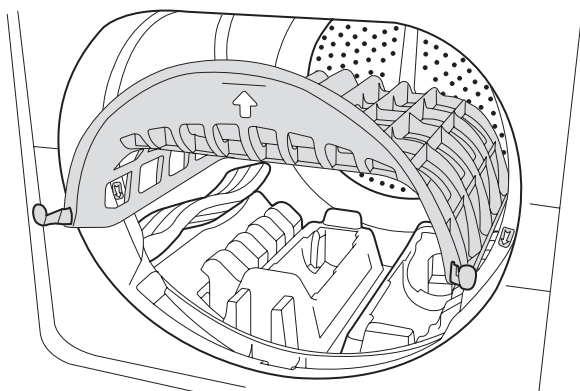
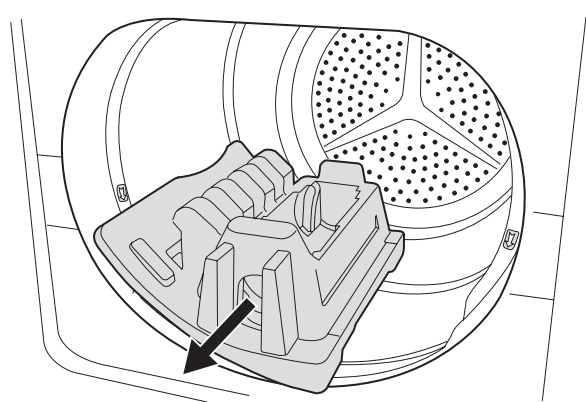

Electrical connection

Details on mains voltage, type of current and the fuses required should be taken from the type plate. The type plate is fitted near the loading aperture (see "Product description" chapter).

Connect the machine to an earthed socket, in accordance with current wiring regulations.

⚠ Warning! The manufacturer declines any responsibility for damage or injury through failure to comply with the above safety precautions. Should the appliance power supply cable need to be replaced, this must be carried out by our Service Center.

⚠ Warning! The plug must be accessible after installing the machine.

Door reversal

To make it easier to load or unload the laundry, the door can be reversed.

Warning! The door must only be reversed by an authorised service engineer.

Please contact your local Service Force Centre. The engineer will carry out the door reversal at your cost.

Special accessories

• Stacking kit

These intermediate installation kits can be used to arrange the dryer and a washing machine (60 cm wide, front loaded) as a space-saving washer/dryer stack. The washing machine is at the bottom and the dryer is at the top. Read carefully the instructions supplied with the kit.

i Available from your Service Force Centre or your specialist dealer

• Draining kit

Installation kit for direct draining of the condensed water into a basin, siphon, gully, etc. The water reservoir then no longer has to be drained, it must however remain in its intended position in the machine.

Fixed hose has to be on the suitable height from minimum of 50 cm to maximum of 1 m from floor level and cannot be looped. If possible shorten the draining hose.

Read carefully the instructions supplied with the kit.

i Available from your Service Force Centre or your specialist dealer

• Pedestal with the drawer

To situate the dryer at the optimal height and have some additional space to store (e.g. laundry).

Read carefully the instructions supplied with the kit.

i Available from your Service Force Centre or your specialist dealer

PRODUCT DESCRIPTION

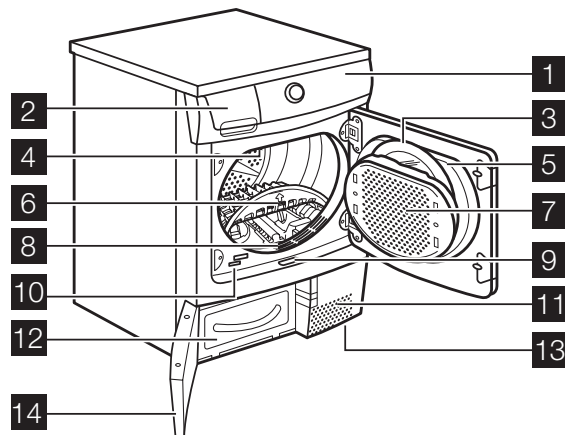

1 Control panel

- 2** Water reservoir
- 3** Fine fluff filters
- 4** Drum light
- 5** Loading door (reversible)
- 6** Drying rack
- 7** Course fluff filters
- 8** Fluff filters
- 9** Push button for base door opening
- 10** Rating plate
- 11** Airflow grille
- 12** Fluff filter
- 13** Adjustable feet
- 14** Heat exchanger door

CONTROL PANEL

Control panel

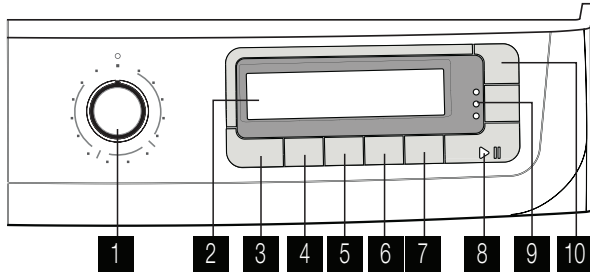

- 1** Programme selector and off switch
- 2** Display
- 3** **Extra delicate** programme selection button
- 4** **Dryness** button
- 5** **Long anti-crease** button
- 6** **Buzzer** button
- 7** **Time** button
- 8** **Start/Pause** button
- 9** Warning lights: Condenser, Filters, Full tank
- 10** **Delay** button

Display



Symbol	Description
	Extra delicate off

Symbol	Description
	Extra delicate on 1)
 MIN	Minimal dryness level
 MED	Medium dryness level
 MAX	Maximal dryness level
 AUTO	Auto dryness level
2 . 3 0	Time to end (time of time programme, time of start delay)
 AUTO	Cycle performance, auto dryness detection
	Long anti-crease guard
	Child lock
	Alarm
	Delay start
	Drying phase
	Cooling phase
	Anti-crease guard phase
Err	Error, wrong selection

1) only for synthetics programmes























BEFORE FIRST USE





Warning! If the appliance was not transported in an upright position, leave it to stand for 12 hours before connecting it to the electricity supply and using it for the first time, so that the oil can flow back to the compressor. Otherwise the compressor could be damaged.

In order to remove any residues which may have been produced during production,

wipe the dryer drum with a damp cloth or carry out a brief drying cycle (ca. 30 min.) with damp cloths in the machine. At the beginning of drying cycle (3-5 min.) there could be a slightly higher sound level. It is because of start of the compressor that is normal for compressor powered appliances such: refrigerators, freezers .

PROGRAMME CHART

Pro-gramme	Load 1)	Application/properties	Options	Care label
 Cottons				
 Extra	7 kg	To dry thick or multi-layered fabrics, e.g. terry towelling items, bathrobes.	Dryness , Long anti-crease , Buzzer , Delay	
 Cup-board	7 kg	To dry fabrics of even thicknesses, e.g. terry towelling items, knitwear, towels.	Dryness , Long anti-crease , Buzzer , Delay	
 Iron	7 kg	To dry normal thickness cotton or linen laundry, e. g. bedding, table linen.	Dryness , Long anti-crease , Buzzer , Delay	
 Synthetics				
 Extra	3 kg	To dry thick or multi-layered fabrics, e. g. pullovers, bedding, table linen.	Extra delicate , Dryness , Long anti-crease , Buzzer , Delay	
 Cup-board	3 kg	To dry thin fabrics which are not ironed, e.g. easy care shirts, table linen, baby clothes, socks, lingerie with bones or wires.	Extra delicate , Dryness , Long anti-crease , Buzzer , Delay	
 Iron	3 kg	To dry thin fabrics which are also to be ironed, e.g. knitwear, shirts.	Extra delicate , Dryness , Long anti-crease , Buzzer , Delay	
 Special				
 Time	7 kg	To dry laundry with the time set by the user.	Long anti-crease , Buzzer , Time , Delay	
 Quick 35'	2 kg	To quickly dry cotton or synthetic clothes in only 35 minutes.	Dryness , Long anti-crease , Buzzer , Delay	
 Mix	3 kg	To dry cotton and synthetic fabrics, uses low temperature.	Dryness , Long anti-crease , Buzzer , Delay	
 Jeans	7 kg	To dry leisure clothing, such as jeans, sweatshirts, etc., of different material thicknesses (e.g. at the neck, cuffs and seams).	Dryness , Long anti-crease , Buzzer , Delay	
 Easy Iron	1 kg (or 5 shirts)	To dry easy care cloths such as shirts and blouses. After this programme the cloths iron easiest. To have good result, we recommend to shake the wet cloths and put straight in the tumble dryer. After the programme end, remove the cloths and put on the cloths hanger.	Dryness , Long anti-crease , Buzzer , Delay	
 Rack				



Pro-gramme	Load 1)	Application/properties	Options	Care label
 Wool 2)	1 kg	To dry the cloths made of wool. With this programme you must set the time with the Time function. We recommend to remove the cloths immediately after the programme end.	Buzzer , Time , Delay	
 Sport Shoes 2)	1 pair	To dry one pair of sport shoes, washed and spun before at 1000 rpm. With this programme you must set the time with the Time function.	Buzzer , Time , Delay	
 Refresh	1 kg	To quickly air the clothes.	Buzzer	





1) maximal weight of dry clothes

2) To dry with the rack only.

DAILY USE



Sorting laundry

- Sort by fabric type:
 - Cotton/linen for programmes in  Cottons programme group.
 - Mixtures and synthetics for programmes in  Synthetics programme group.
- Sort by care label: The care labels mean:

	Drying in the tumble dryer possible in principle
	Drying at normal temperature
	Drying at reduced temperature
	Drying in the tumble dryer not possible

Important! Do not place in the appliance any wet laundry which is not specified on the care label as being suitable for tumble-drying.

This appliance can be used for all wet laundry items which are labelled as suitable for tumble-drying.

- Do not dry new, coloured textiles together with light-coloured laundry items. Textile colours may bleed.
- Do not dry cotton jersey and knitwear with the  Extra programme. Items may shrink!
- Wool and wool-like textiles can be dried using the  Wool programme. Before the drying cycle spin the woollen textiles

as well as possible (max. 1200 rpm). Only dry woollen textiles together of similar or the same material, colour and weight. Please dry heavy laundry items made of wool separately.

Preparing laundry

- To avoid laundry becoming tangled: close zips, button up duvet covers and tie loose ties or ribbons (e.g. of aprons).
- Empty pockets. Remove metal items (paper clips, safety pins, etc).
- Turn items with double-layered fabrics inside out (e.g. with cotton-lined anoraks, the cotton layer should be outermost). These fabrics will then dry better.

Important! Do not overload the appliance. Observe max. loading volume of **7 kg**.

Average laundry weights

bathrobe	1200 g
quilt cover	700 g
man's work shirt	600 g
man's pyjamas	500 g
sheet	500 g
tablecloth	250 g
man's shirt	200 g
night dress	200 g
pillow case	200 g
towelling towel	200 g

blouse	100 g
ladies' briefs	100 g
men's underpants	100 g
napkin	100 g
tea cloth	100 g

Switching machine on

Turn the programme selector to any programme. The machine switches on. When the loading door is open, the internal lamp illuminates the drum.

Operating

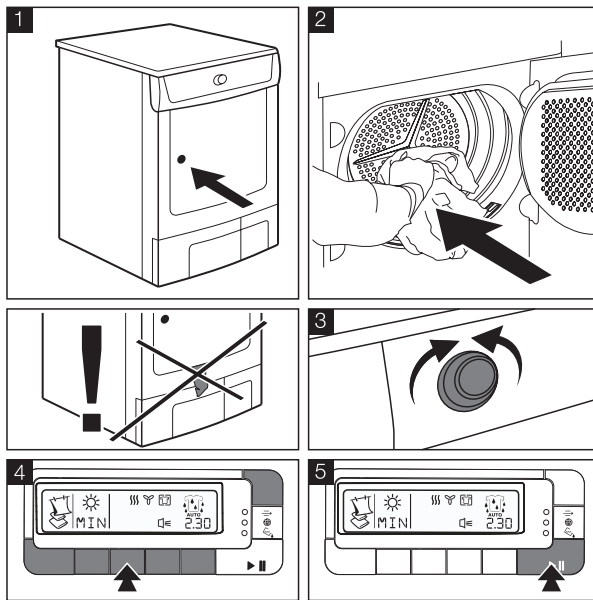

Drying options

Extra delicate

this function decreases the movement of the laundry during the cycle. The laundry after the cycle is more soft and loose. For synthetic programmes only.

Dryness

increases the dryness of the dried laundry adequately to the selected level:



MAX - *maximum*



MED - *medium*



MIN - *minimum*



AUTO - *inactive with some programmes*

this option helps to achieve satisfying result of drying

Long anti-crease

prolongs anti-crease phase to 90 min., helps to keep laundry free from creases after drying; laundry can be removed at any time

Buzzer

audible confirmation of:

- cycle end
- anti-crease phase start and end
- cycle interruption
- error

Time

allows to set individual time of drying from minimum 20 min. to maximum of 3 hours (in 10 min. steps - press the button repeatedly until the desired programme duration is shown in the display, e.g. **1 20** - for a programme of 1 hour and 20 minutes); active with suitable programme

Delay

allows to delay the start of a drying programme from minimum of 30 min. to maximum of 20 hours

1. select the drying programme and additional drying options
2. press the Delay button repeatedly until the desired delay start is shown on the display, e.g. **12 H** if the programme has to start after time of 12 hours
3. to activate the delay timer, press the Start/Pause button - time to start elapses on the display

Starting the programme

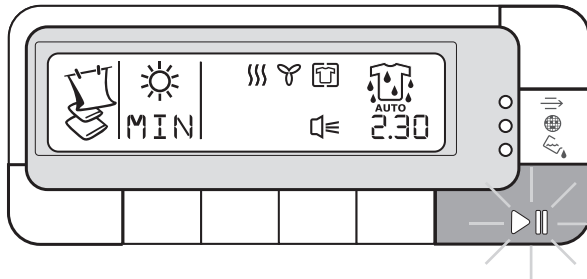

Press the Start/Pause button. The programme starts.

The programme progress is shown by

elapsing *dry time* and animated icon on LCD.



Setting child lock

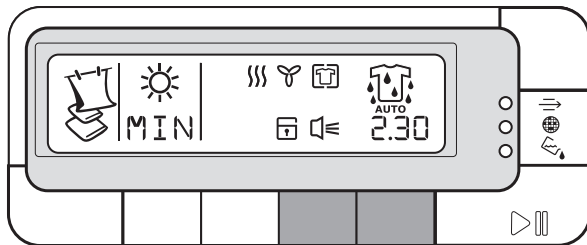

The child lock can be set to prevent a programme being accidentally started or a programme in operation being accidentally changed. The child lock function locks all buttons and the programme selector. The child lock can be activated or deactivated by holding down the Buzzer and Time buttons simultaneously for 5 seconds.

The symbol:  on the display means that the child lock is active.

- i** Any changes of drying parameters require child lock deactivation. The child lock cannot be deactivated in the last phase of the drying cycle.





Changing programme

To change a programme which has been selected by mistake once the programme has started, first turn the programme selector to  *off* and then reset the programme.

- i** The programme can no longer be changed directly once the programme

has started. If nevertheless there is an attempt to change the programme on the programme knob, the programme progress display and the maintenance indicators flash. If an option button (excluding the Buzzer button) is pressed,  appears on the display. The drying programme is not however affected by this (laundry protection).

Drying cycle complete / removing laundry

Once the drying cycle is complete, the display shows the anti-crease icon  and flashing  as well as warning lamps:  *filter* and  *full tank*. If the Buzzer button has been pressed, an acoustic signal sounds intermittently for about one minute.

- i** The drying cycles (except from the Wool programme) are automatically followed by an anti-crease phase which lasts around 30 minutes. The drum rotates at intervals during this phase. This keeps the laundry loose and free of creases. The laundry can be removed at any time during the anti-crease phase. (The laundry should be taken out towards the end of the anti-crease phase at the latest to prevent creases from forming.) If Long anti-crease function has been selected, the anti-crease phase is lengthened by 60 minutes.

1. Open door.
2. Before removing the laundry, remove fluff from the micro-fine filter. It is best to use a damp hand for this purpose. (See "Cleaning and maintenance".)
3. Remove laundry.
4. Turn the programme selector to  *off*.

Important! After each drying cycle:

- Clean the micro-fine filter and fine filter
- Drain the condensed water container (See chapter "Cleaning and maintenance".)
- 5. Close the door.

DRYING RACK

Special equipment for gentle drying washable woollens and sport shoes. Incomparable for drying wet woollens - eliminated movement, protection from matting.

i For drying rack unpacking see *Installation* chapter.

Important! Before drying rack installation check the dryer drum. **It must be empty!** Sport shoes cannot be dry without the drying rack - drum damage.

Installation and use

1. Open the loading door.
2. Insert the rack carefully resting its two support brackets on the front of plastic flange.

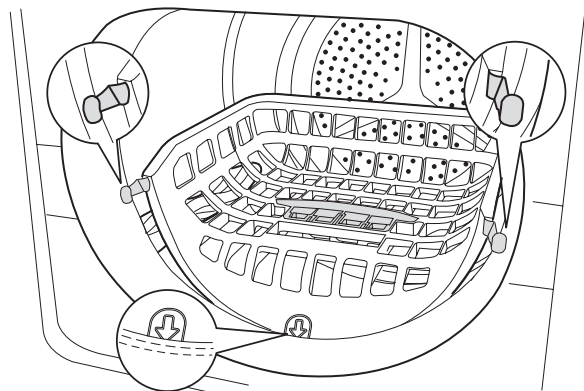
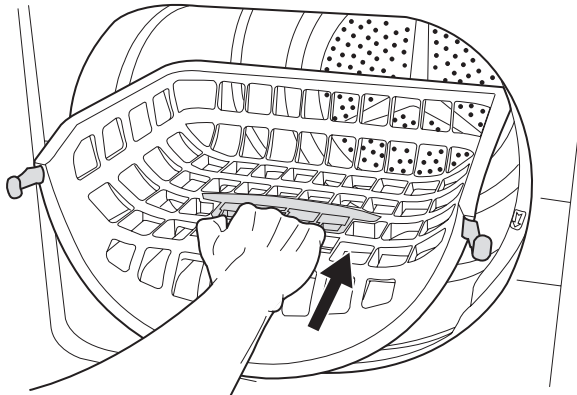

3. Place the woollens or pair of sport shoes on the rack.
4. Select the suitable rack drying programme and drying time.
5. Press the START/PAUSE button.
6. When cycle is finished open the loading door and remove the woollens or shoes.
7. Turn the programme selector to OFF.

8. Take out the drying rack of the drum.

Drying tips

- for the best drying result spread the woollens out loosely on the drying rack and roll it up
- do not squash and fold the woollens

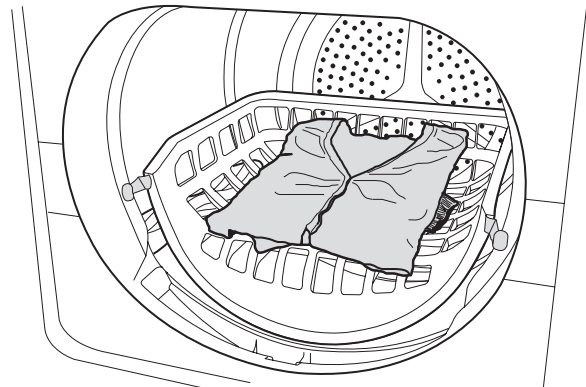

- open support and put sport shoes on it

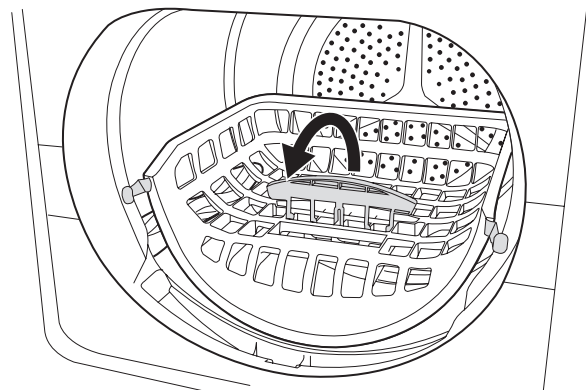

- the insoles should be placed beside the shoes on the drying rack and the shoelaces should be tied

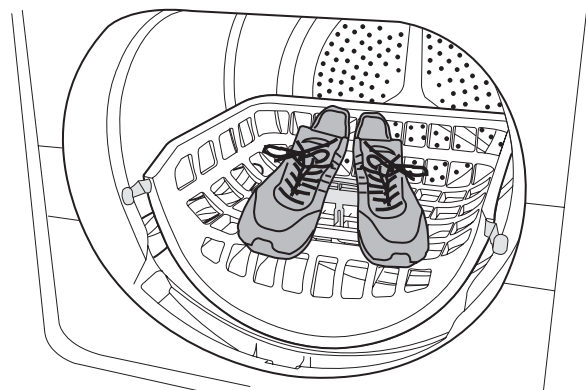

CLEANING AND MAINTENANCE

Cleaning fluff filters

The filters collect all the fluff which accumulates during drying. To ensure that the dryer works perfectly, the fluff filters (fine filters and fluff filters) must be cleaned after each drying cycle.

! **Caution!** Never operate the dryer without fluff filters or with damaged or blocked fluff filters.

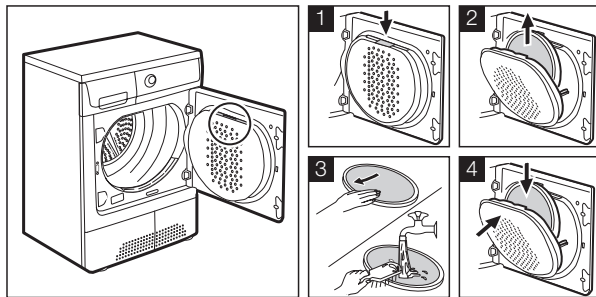
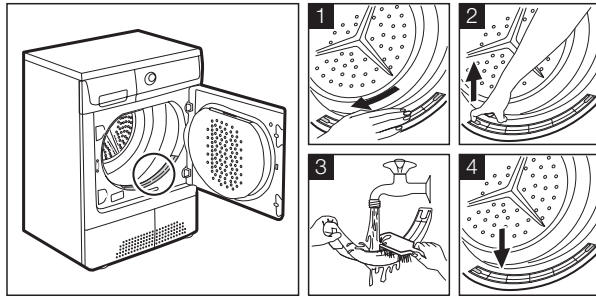
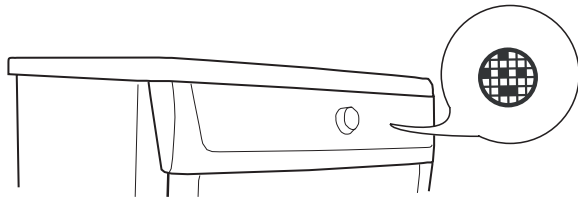

Clean the door seal

Wipe the door seal with a damp cloth immediately after the drying cycle has finished.

Emptying the water reservoir

Empty the water reservoir after every drying cycle.

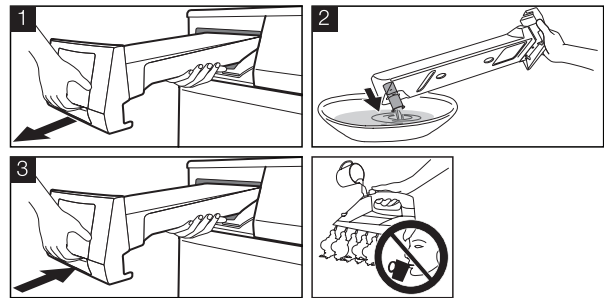
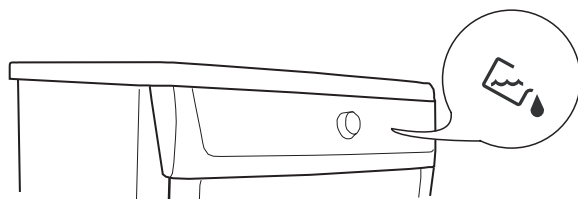

! **Warning!** The condensed water is not suitable for drinking or for preparing foodstuffs.

i If the programme has been interrupted as a result of the water reservoir being full: Press the Start/Pause button to continue the drying cycle.

Cleaning heat exchanger filter

Important!

- Never operate the dryer without the fluff filters.
- Clogged filters cause higher energy consumption (drying cycle elongation) and dryer damage.
- A dirty heat pump can only be cleaned up by means of a costly process.
- As necessary, approx. once every 6 months, remove the fluff from the heat exchanger using the sponge supplied. When doing this, please use rubber gloves (picture 7).

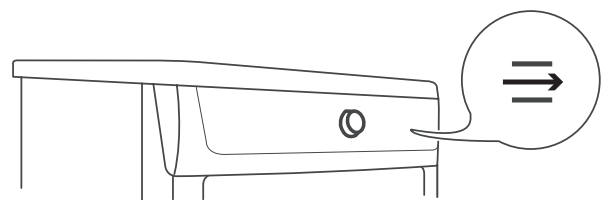

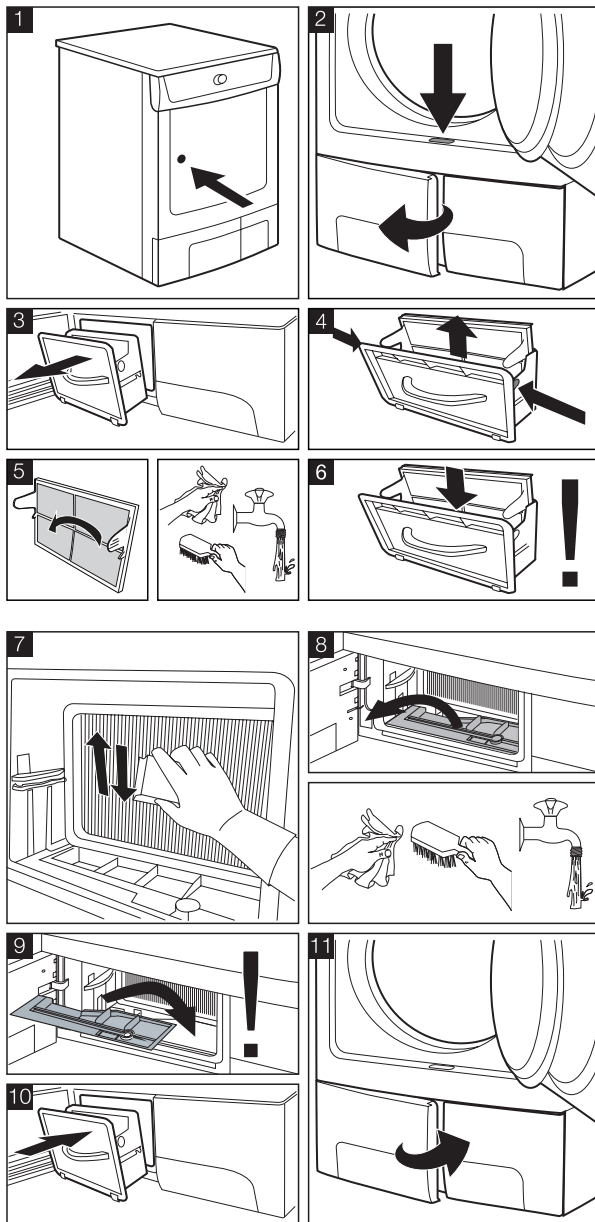

Cleaning the drum

⚠ Caution! Do not use abrasives or steel wool to clean the drum.

i Lime in the water or cleaning agents may form a barely visible lining on the inside of the drum. The degree to which the laundry has been dried is then no longer detected reliably. The laundry is damper than expected when removed from the appliance.

Use a standard domestic cleaner (e.g. vinegar-based cleaner) to wipe down the inside of the drum and drum ribs.

Clean control panel and housing

⚠ Caution! Do not use furniture cleaners or aggressive cleaning agents to clean the machine.

Use a damp cloth to wipe down the control panel and housing.

WHAT TO DO IF ...

Troubleshooting by yourself

Problem ¹⁾	Possible cause	Remedy
Dryer does not work.	Dryer not connected to mains supply.	Plug in at mains socket. Check fuse in fuse box (domestic installation).
	Loading door opened.	Close loading door
	The START PAUSE button not pressed.	Press the START PAUSE button.
	Incorrect programme set.	Set suitable programme. ²⁾
Unsatisfactory drying results.	Fluff filters clogged.	Clean fluff filters. ³⁾
	Heat exchanger clogged.	Clean heat exchanger. ³⁾
	Max. loading exceeded.	Respect max. loading volume.

	Covered ventilation grill.	Uncover ventilation grill in base area.
	Residue inside the drum.	Clean the drum inside.
	High water hardness.	Set suitable water hardness ⁴⁾ .
Loading door does not close	Filters not locked in place.	Install fine filter and/or snap course filter into place.
Err (Error) on the LCD. ⁵⁾	Attempt to change parameters after start of the programme.	Turn the dryer off and on. Set requested parameters.
No drum light	Programme selector in OFF position.	Turn it to DRUM LIGHT (if available) or to any programme.
	Defective light bulb.	Replace light bulb (see next section).
Abnormally elapsing time on the LCD ⁵⁾	Time to end is calculated on the basis of: type, volume and dampness of laundry.	Automatic process; this is not a machine fault.
Programme inactive	Full water reservoir.	Empty water reservoir ³⁾ , press START PAUSE button.
Drying cycle to short	Small laundry volume./Too dry laundry for selected programme.	Select time programme or higher drying level (e.g. EXTRA DRY).
Drying cycle to long ⁶⁾	Fluff filters clogged.	Clean fluff filters.
	To high loading volume.	Respect max. loading volume.
	Laundry insufficiently spun.	Spun adequately the laundry.
	Particularly high room temperature - no machine fault.	Lower the room temperature if possible.

1) In case of error message on the LCD (e.g. **E51**- only dryers with the LCD): Switch the dryer off and on. Set programme. Press the START PAUSE button. Does not work? - inform local service and quote the error code.

2) follow program recommendation - see Programme overview chapter

3) see Care and cleaning chapter

4) see Machine settings chapter

5) only dryers with the LCD

6) Note: After around 5 hours the drying cycle ends automatically (see Drying cycle complete section).

Changing the bulb for interior lighting

Only use a special bulb which is designed specially for dryers. The special bulb can be obtained from your local service centre.

Important! When the appliance is switched on, the interior lighting switches itself off after 4 minutes when the door is open.

 **Warning!** Do not use standard bulbs! These develop too much heat and may damage the appliance! Before replacing the bulb, disconnect the mains plug; with a permanent connection: fully unscrew or deactivate the fuse.

1. Unscrew cover above the bulb (this can be found directly behind the loading aperture, at the top; refer to "Description of machine" section.)
2. Replace defective bulb.
3. Screw cover back down.

Check the correct positioning of o-ring gasket before screwing back the door light cover. Do not operate the dryer when missing o-ring gasket on door light cover.

 **Warning!** For safety reasons, the cover must be screwed down tightly. If this is not done, the dryer must not be operated.

TECHNICAL INFORMATION



height x width x depth	85 x 60 x 58 cm
drum volume	108 l
depth with the load door opened	109 cm
adjustable height	1.5 cm
the appliance weight	59 kg
maximum load volume	7 kg
voltage	230 V
necessary fuse	6 A
total power	900 W
energy efficiency class	A
energy consumption kWh/cycle ¹⁾	1,58 kWh
annual energy consumption	104,4 kWh
type of use	Domestic
permitted ambient temperature	+ 5°C to + 35°C

1) 7 kg of cotton, centrifuged at 1000 rpm with reference to EN 61121

MACHINE SETTINGS

Setting	Implementation
Buzzer permanent on/off	The alarm is by default always off. To set permanent alarm on (off): 1. Turn the programme selector to any programme. 2. Press simultaneously the Dryness and Long anti-crease buttons and hold down for approx. 5 seconds.
Water hardness¹⁾	1. Turn the programme selector to any programme. 2. Press simultaneously the Long anti-crease and Start/Pause buttons and hold down for approx. 5 seconds. 3. Press the Start/Pause button until you set desired level: [0] - low conductivity <300 µS/cm [0 =] - medium conductivity 300-600 µS/cm [0 =] - high conductivity >600 µS/cm 4. To memorize setting press simultaneously the Long anti-crease and Start/Pause buttons or turn knob to  off position

1) Water contains, a variable quantity of limestone and mineral salts of which quantities vary according to geographical locations thus varying its conductivity values. Relevant variations of the conductivity of the water compared to those prefixed by the factory could slightly influence the residual humidity of the laundry at the end of the cycle. Your dryer allows you to regulate the sensitivity of the drying sensor based on conductivity values of the water.

SERVICE

If there are technical faults, first check if you can remedy the problem yourself with the help of the operating instructions - see chapter *What to do if...*

If you cannot remedy the problem on your own, get in touch with the Customer Care Department or one of our service partners. To assist you quickly, these data are necessary:

- Model description
- Product number (PNC)
- Serial number (S No. is on rating plate stuck to the product - to find it see chapter *Product description*)
- Type of failure
- Any error messages shown by the display.

So that you have the necessary reference numbers from your appliance at hand, we recommend that you write them in here:

Model description:
PNC:
S No:



www.electrolux.com/shop

