

▶ KDK911423  
KDK911413  
KDE911423  
KDE911413

<b>EN</b>	<b>Instructions</b>	2
	Vacuum Drawer	
<b>FR</b>	<b>Mode d'emploi</b>	18
	Tiroir pour sous-vide	
<b>DE</b>	<b>Bedienungsanleitung</b>	32
	Vakuüm-Lade	
<b>IT</b>	<b>Istruzioni per l'uso</b>	46
	Cassetto per sottovuoto	

# USER MANUAL



**AEG**

# CONTENTS

1. SAFETY INFORMATION.....	3
2. SAFETY INSTRUCTIONS.....	4
3. PRODUCT DESCRIPTION .....	6
4. CONTROL PANEL .....	6
5. BEFORE USING FOR THE FIRST TIME.....	7
6. DAILY USE .....	7
7. CLEANING AND MAINTENANCE.....	12
8. TROUBLESHOOTING.....	13
9. WARRANTY .....	15
10. ENVIRONMENTAL CONSIDERATIONS .....	17

## FOR PERFECT RESULTS

Thank you for choosing this AEG product. We have created it to give you impeccable performance for many years, with innovative technologies that help make life simpler – features you might not find on ordinary appliances.

Please spend a few minutes reading to get the very best from it.

### Visit our website to:



Receive advice, download our brochures, solve any anomaly and find information on technical support:

**[www.aeg.com](http://www.aeg.com)**



Register your product and receive a better service:

**[www.aeg.com/productregistration](http://www.aeg.com/productregistration)**



Purchase accessories, consumables and original spare parts for your appliance:

**[www.aeg.com/shop](http://www.aeg.com/shop)**

## CUSTOMER SERVICE AND MAINTENANCE

We recommend always using original spare parts.

Always have the following information at hand when you contact the authorised Assistance Centre: Model, PNC and serial number.

You can find the information on the rating plate.

 Warning/Attention - Important safety information.

 Information and general recommendations.

 Environmental information.

Subject to change without notice.

# 1. SAFETY INFORMATION

Carefully read the instructions before installing and using the appliance. The manufacturer is not liable for improper installation and use of the appliance that may cause injuries and damage. Always keep the instructions available for future reference.

## 1.1 Safety of children and vulnerable adults

- This appliance can be used by children aged 8 years and above and persons with reduced physical, sensory or mental capabilities or lack of experience and knowledge only if they are given supervision or trained on how to use the appliance in a safe way and understand the hazards involved.
- Children should not play with the appliance.
- Keep packaging materials away from children.
- Keep children and pets away from the appliance during operation.
- Cleaning and maintenance should not be done by children without supervision.
- Children under the age of 3 years must be kept away unless constantly supervised.

## 1.2 Warnings on general safety

- Only qualified personnel can install the appliance and replace the cables.
- Disconnect the appliance from the power supply before carrying out any maintenance operation.
- Do not use steam cleaners to clean the appliance.
- Do not use abrasive detergents or metal scrapers to clean the appliance.
- If the power cord is damaged it must be replaced by the manufacturer, by an authorised technician or by a qualified person to prevent hazardous situations.

## 2. SAFETY INSTRUCTIONS

### 2.1 Installation



#### CAUTION!

The appliance must be installed by qualified personnel only.

- Remove the packaging material.
  - Do not install or use the appliance if damaged.
  - Comply with the instructions supplied with the appliance.
  - Always pay attention when moving the appliance. Always wear safety gloves.
  - Do not turn the appliance upside down or tilt it! This may cause oil to leak from the pump and damage the equipment.
  - Respect the minimum distance from other appliances.
  - Make sure the appliance is installed and secured to a fixed structure.
  - The sides of the appliance must be adjacent to other equipment or units having the same height.
- Use only suitable isolation devices: circuit breakers, fuses (screw type fuses must be removed from the fuse holder), earth fault current releases and relays.
  - The electric system must be equipped with an isolation device that allows you to disconnect the appliance from the mains at every pole. The isolation device must have a contact opening width of a minimum 3 mm.
  - This appliance complies with the EEC directives.

### 2.2 Electrical connection



#### CAUTION!

Risk of fire and electric shock.

- All the electrical connections must be made by a qualified electrician.
- The appliance must be earthed.
- Make sure that all the electrical data shown on the data plate correspond to those of the system. Otherwise, contact an electrician.
- Always use an electrical outlet with a correctly installed protective contact.
- Do not use multi-plug adapters or extension cables.
- Make sure not to damage the mains plug and the mains cable. If the power cable must be replaced, this should be carried out by our Assistance Centre.
- Shock protection devices must be fastened in such a way that they cannot be removed without tools.
- Connect the mains plug to the mains socket only once installation has been completed.
- Do not connect the mains plug if the mains socket is loose.
- Do not pull the mains cable to disconnect the appliance. Pull only the mains plug.

## 2.3 Use



### CAUTION!

Risk of injury, burns, electric shock or explosion.

- Do not touch the sealing bar after use. Residual heat can cause burns.
- Use this appliance only in a household environment.
- Do not modify the specifications of this appliance.
- Do not leave the appliance unattended during operation.
- Turn the appliance off after use.
- Do not use the appliance with wet hands or when it could come into contact with water.
- Do not apply pressure on the drawer.
- Do not use the appliance as a work surface or as a support surface.
- Avoid the presence of sparks or open flames near the appliance when you open the drawer.
- Do not place or keep flammable liquids, materials or objects on the appliance, or inside or close to it.



### CAUTION!

You may damage the appliance.

- Pay attention when you remove or insert the accessories.
- Do not force the cover open during the work cycle.
- Do not force the cover open during the work cycle in the case of a power cut.
- Do not place any weight on the cover.
- Prevent any object from falling on the cover! This can compromise the integrity, causing cracks or damage.

## 2.4 Cleaning and maintenance



### CAUTION!

There is a risk of injury, fire or damage.

- Before carrying out any maintenance operation, turn the appliance off and disconnect the plug from the mains socket.
- Check that the appliance is cold.

## 2.5 Disposing of the appliance



### CAUTION!

Risk of injury and choking.

- Disconnect the plug from the power supply.
- Remove the mains cable and dispose of it.

## 2.6 Technical Assistance

- Contact the authorised Assistance Centre to repair the appliance.
- Only use original spare parts.

### 3. PRODUCT DESCRIPTION

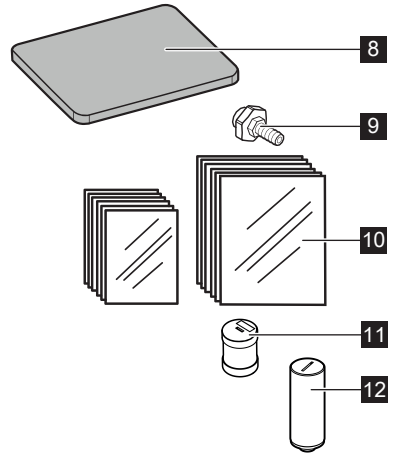
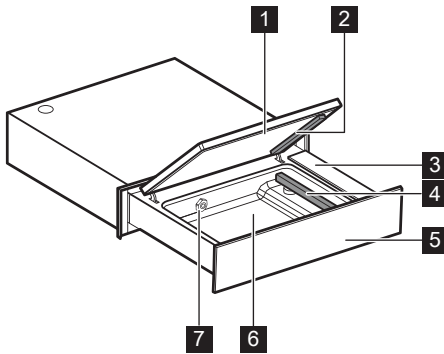

- 1** Cover
- 2** Sealing cushion
- 3** Control panel
- 4** Sealing bar
- 5** Front panel
- 6** Tank
- 7** Suction nozzle

- 8** Filler plate
- 9** Fitting for external vacuum
- 10** Pouches for freezing, cooking and storage  
25 pouches 20x30 cm  
25 pouches 25x35 cm
- 11** Oil filter
- 12** Cap

### 4. CONTROL PANEL

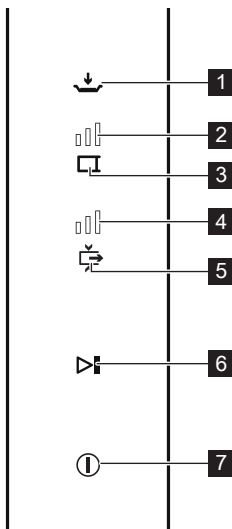

- 1** MARINADE/INFUSION button
- 2** SEALING time indicator
- 3** SEALING time button
- 4** VACUUM level indicator
- 5** VACUUM level button
- 6** START/STOP button
- 7** ON/OFF button

## 5. BEFORE USING FOR THE FIRST TIME

**CAUTION!**

Refer to the chapters on safety.

**CAUTION!**

Pour the oil in the machine before installation.

**CAUTION!**

Comply with the instructions supplied with the appliance.

**CAUTION!**

The plastic cap **12** removed during installation must be kept for future assistance.

### 5.1 Cleaning for the first time

- Refer to the “CLEANING AND MAINTENANCE” chapter.
- Wipe all parts with a damp cloth before the first use.

### 5.2 First use

Turn the appliance on by holding down the **ⓘ** button for at least 1 second.















If only the **▶||** button starts flashing, run the release procedure (see installation instructions - phase 13). Otherwise run an oil reconditioning cycle as stated in par. 6.6.





## 6. DAILY USE

This product is ideal for:

- Vacuum food packaging for “SousVide” low temperature cooking.
- Vacuum packaging for food preservation.
- Food marinade/infusion.

Button	Description	Function
	ON/OFF button	Turning the appliance on/off.
	START/STOP button	To start/stop the packaging cycle.
	VACUUM button	Set one of the 4 vacuum levels available. The preset value is MAX.
		 only sealing
		 MIN.
		 MED.
		 MAX.
	Button SEALING	Set the sealing time according to the thickness of the pouch <sup>1)</sup> . The appliance is preset to 2.5 s, which is the ideal time for the pouches provided.
		 disabled
		 1.5 s
		 2.5 s
		 4.0 s
	MARINADE/ INFUSION button	To activate the marinating/infusion function.

<sup>1)</sup> The thicker the pouch, the longer the set time.

- Open the drawer completely.
  - Turn the appliance on by holding down the  button for at least 1 second.
  - If necessary, modify the vacuum level and the sealing time.
  - Lift the cover and place the pouch containing the food to be packed inside the tank, leaving at least 2 cm beyond the sealing bar.
  - It is important not to soil the pouch in the sealing area so as to guarantee a perfect seal. For this reason it is advisable to fold the inner side of the pouch outwards by 4-5 cm. Once the food is inserted, fold the pouch again in its initial condition.
  - For small products, use the supplied filler plate, as it helps position the pouch in the correct position with respect to the sealing bar.
  - Close the cover with light pressure and press the  button which begins to flash. The packaging cycle will then start.
  - The button stops flashing at the end of this cycle.
  - Open the cover and remove the pouch.
-  Do not touch the sealing bar after use. Residual heat can cause burns.
- Turn the appliance off while holding down the  button.
-  If the appliance is not used for 60 minutes it switches off automatically.







**Liquid food**

If the ▶|| button is pressed during operation, the cycle stops and the pouch is immediately sealed. This procedure must be used for packing liquid products, which may boil during the vacuum cycle.



Note: Periodically, the appliance automatically performs a reconditioning cycle (see par. 6.6) during which the ▶|| and ✕ buttons flash. Allow the cycle to run without intervening on the appliance until the 2 buttons will stop flashing.

Depending on the food to be packed, it is advisable to set the vacuum level as shown in the table:

Vacuum level 	Use
	Package and divide into portions without creating vacuum. <sup>1)</sup>
	Package and divide into portions of particularly delicate food (salad, tomatoes, etc.) with the minimum vacuum level (MIN).
	<ul style="list-style-type: none"> <li>- Package and divide delicate food into portions (cooked vegetables, fruit, tender meat, pasta) and liquid food (soup, cream, sauce).</li> <li>- Marinate in the pouch.</li> <li>- Vacuum cook (SousVide) delicate food (e.g. fish) with the medium vacuum level (MED).</li> </ul>
	<ul style="list-style-type: none"> <li>- Package and divide solid food into portions (raw vegetables, hard cheese, cold cuts).</li> <li>- Vacuum cook (SousVide) solid food (e.g. meat, potatoes, carrots, etc.) with the maximum vacuum level (MAX).</li> <li>- Airtight sealing of glass jars (see par. 6.5).</li> </ul>

<sup>1)</sup> This function still produces light vacuum inside the pouch.

## 6.1 Using the pouches

The pouches provided are ideal for freezing, storage and cooking vacuum packed food at low temperatures.

### **Pouches order code: 902979704**

50 pouches for freezing, vacuum cooking and storage  
(25 pieces, dimensions: 20x30 cm + 25 pieces, dimensions: 25x35 cm)

### **Pouches order code: 9029794014**

50 pouches for vacuum cooking and storage  
(25 pieces, dimensions: 20x30 cm + 25 pieces, dimensions: 25x35 cm)



It is recommended to use original pouches.

[www.aeg.com/shop](http://www.aeg.com/shop)

## 6.2 Vacuum food packaging for “SousVide” low temperature cooking

With this method, the food sealed in the vacuum pouch is then cooked slowly at low temperature.

### **The benefits provided are many:**

- The flavour and texture remains unaltered.
- Both flavour and aromas are preserved, as the cooking process does not disperse them.
- The reduced loss of liquid makes the food softer and moister.
- Nutrients are preserved.
- You don't need to add oils or fats for cooking.

## 6.3 Vacuum packaging for food preservation

Vacuum packing extends food preservation.

If you wish to vacuum pack freshly cooked food, it must first be chilled, possibly using a blast chiller.

## 6.4 Marinades/infusion

- Place the food with the marinade in a generic pan/dish.
- Turn the appliance on by holding down the **ⓘ** button for at least 1 second.
- Lift the cover and place the pan in the tank.
- Press the  button, which will start to flash.
- Close the cover with light pressure.
- Press the **▶||** button to start the marinade cycle. This button will start to flash.
- This button will stop flashing once the marinating cycle is completed.
- The cover can then be opened and the pan removed.

The marinating and infusion cycle has a preset time of 8 minutes. Increase the infusion and repeat the cycle.

This infusion can be deactivated at any time by pressing the **▶||** button.







You can marinate food directly in the pouch.  
In this case, set the relevant vacuum level.

## 6.5 Additional functions

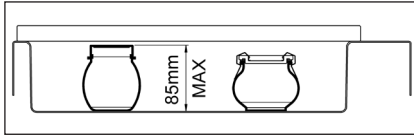
### “Airtight sealing of glass jars”

This is the function for the airtight sealing of glass jars to be used for jar-cooking or for increasing the shelf-life of the product (jars not provided with this appliance).



- Set the maximum vacuum level  and disable the sealing .
- Close the jar with slight pressure and put it in the tank, close the cover exerting slight pressure, and press the  button which will start to flash. The packaging cycle will then start.
- The button stops flashing at the end of this cycle.



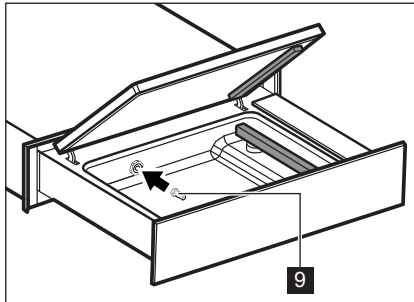

### “External vacuum”

It is to be used to eliminate the air inside special air-tight containers (not supplied with this appliance).

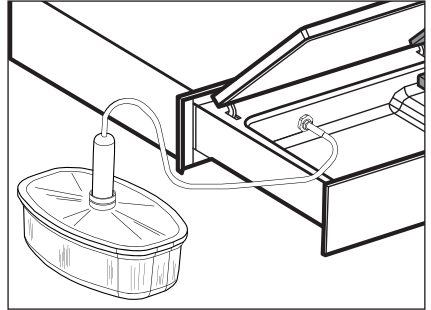

- For the external vacuum, tighten the fitting  provided, inside the tank.



- Connect the container pipe to the fitting .
- Set the maximum vacuum level  and disable the sealing .
- With the appliance cover open press the  button to start the packaging cycle. This button will start to flash.
- The button stops flashing at the end of this cycle.

## 6.6 Reconditioning cycle

This function is used in the following situations:

- Before using the appliance for the first time.
- After extensive downtime.
- After having sealed products with high humidity content (e.g. soups).
- When you notice a decrease in appliance performance (e.g. more time to vacuum or it does not vacuum at all).





This program lasts about 15 minutes and guarantees the complete cleaning of the pump, removing any liquid emulsion that might be found in the oil.

Do not seal any product while this program is running.

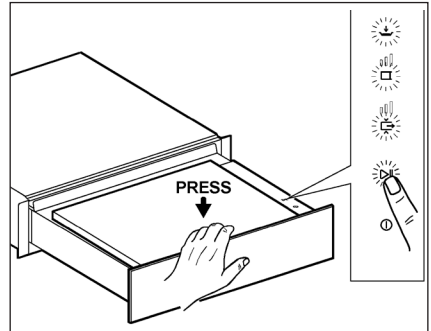
Proceed as follows:

- Hold down the  button until all the buttons flash.



- Close the cover with light pressure.
- Press the  button. The  and  buttons flash while the program runs.
- At the end of the cycle (15 minutes) the  button will stop flashing and the appliance will be ready for use.

## 7. CLEANING AND MAINTENANCE



### CAUTION!

Refer to the chapters on safety.

- Clean the appliance after each use with a damp and soft cloth.

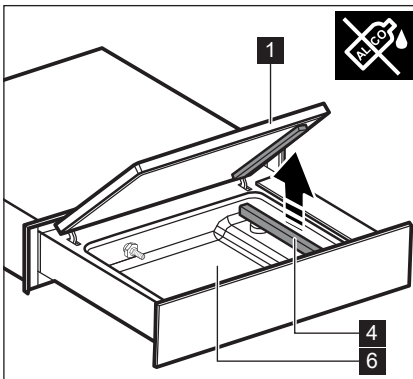

- Clean the Plexiglas cover **1** inside and out using only neutral detergents (water and soap).
- Do not use abrasive products, alcohol-based detergents, abrasive sponges, solvents or metal objects.
- Follow the safety instructions indicated on the packaging when using products to clean the steel tank **6**.
- Clean the tank **6**, especially in the case of residue liquid, it is advisable to remove the sealing bar **4** upwards.
- Clean the sealing bar **4** with a dry cloth. Remove any residue that deposits on the bar.
- Clean the metal surfaces using normal detergents suitable for stainless steel.
- Keep the control panel clean and dry.



## 8. TROUBLESHOOTING



### CAUTION!











Refer to the chapters on safety.

### 8.1 What to do if...

Problem	Possible cause	Solution
The pouch is not sealed correctly.	The sealing time is not correct.	Change the sealing time.
	The cover gasket is dirty or worn.	Clean or replace the cover gasket (contact the Technical Assistance Service for a replacement).
	The pouch is not placed correctly on the sealing bar.	Position the pouch correctly.
	The sealing bar is worn (the Teflon coating is burnt).	Replace the sealing bar (contact the Technical Assistance Service for a replacement).
	The blade placed under the Teflon of the sealing bar is broken.	Replace the blade (contact the Technical Assistance Service for a replacement).
Final vacuum is poor.	The set vacuum level is not correct.	Change the vacuum level.
	The cover gasket is dirty or worn.	Clean or replace the cover gasket (contact the Technical Assistance Service for a replacement).
	The cover is not closed correctly.	Close the cover correctly. Make sure that objects or dirt are not found between the cover and tank.
	Impurities contained in the pump oil.	Run an oil "reconditioning cycle" (see par. 6.6).
The cover does not open.	No power supply.	Wait until the power supply is restored.
The cover is cracked or broken.	Damaged cover.	Replace the cover (contact the Technical Assistance Service for a replacement).
The  and  buttons flash.	"Reconditioning cycle" in progress.	Wait for the end of the "reconditioning cycle" (15 minutes).

The machine turns off and the pump activates automatically after the cover is closed.	The oil reconditioning program has been automatically activated (see par. 6.6).	Wait for the end of the “reconditioning cycle” (15 minutes).
The vacuum cycle starts, activating the vacuum pump, but then stops within a few seconds and the button will flash  (without evacuating the tank or sealing the bag).	The cover has not been closed.	Apply light pressure to the top of the cover to create an airtight seal.
	The cover gasket is dirty or worn.	Clean the gasket. Replace the gasket.

### Alarm messages

Alarm	Possible cause	Solution
The  button will flash continuously.	The electrical board is faulty.	Contact the Technical Assistance Service.
The  button will flash continuously.	The vacuum is not produced.	Clean or replace the cover gasket (contact the Technical Assistance Service to replace it). Make sure the cover closes correctly. Press the  button to reset the alarm.
The  and  buttons flash continuously.	The pump oil must be replaced.	Contact the Technical Assistance Service.
The  button flashes continuously.	The packaging cycle is terminated in advance because a wet product is being packaged.	Press the  button to reset the alarm.
Only the  button flashes continuously.	The machine is in “first start-up” mode (see the installation instructions – phase 13).	Close the cover with light pressure and press the  button. All of the buttons light up and the oil reconditioning cycle starts (  flash). Wait 15' for the procedure to finish.

## 8.2 Assistance Data

If it is not possible to find a solution to the problem, contact the authorised Assistance Centre.

The information required for the Assistance Centre is found on the data plate on the left side of the appliance. Do not remove the data plate.

## 9. WARRANTY

FOR SALES IN AUSTRALIA AND NEW ZEALAND

ALL AEG BRANDED APPLIANCES

**This document sets out the terms and conditions of the product warranties for AEG Appliances. It is an important document. Please keep it with your proof of purchase documents in a safe place for future reference should you require service for your Appliance.**

1. In this warranty
  - a) 'acceptable quality' as referred to in clause 10 of this warranty has the same meaning referred to in the ACL;
  - b) 'ACL' means Schedule 2 to the Competition and Consumer Act 2010;
  - c) 'Appliance' means any AEG product purchased by you and accompanied by this document;
  - d) 'ASC' means AEG authorised service centres;
  - e) AEG is the brand controlled by Electrolux Home Products Pty Ltd of 163 O'Riordan Street, Mascot NSW 2020, ABN 51 004 762 341 in respect of Appliances purchased in Australia and Electrolux (NZ) Limited (collectively 'Electrolux') of 3-5 Niall Burgess Road, Mount Wellington, in respect of Appliances purchased in New Zealand;
  - f) 'major failure' as referred to in clause 10 of this warranty has the same meaning referred to in the ACL and includes a situation when an Appliance cannot be repaired or it is uneconomic for Electrolux, at its discretion, to repair an Appliance during the Warranty Period;
2. This warranty only applies to Appliances purchased and used in Australia or New Zealand in normal domestic applications and is in addition to (and does not exclude, restrict, or modify in any way) any non-excludable statutory warranties in Australia or New Zealand.
3. During the Warranty Period Electrolux or its ASC will, at no extra charge if your Appliance is readily accessible for service, without special equipment and subject to these terms and conditions, repair or replace any parts which it considers to be defective. Electrolux or its ASC may use remanufactured parts to repair your Appliance. You agree that any replaced Appliances or parts become the property of Electrolux. This warranty does not apply to light globes, batteries, filters or similar perishable parts.
4. Parts and Appliances not supplied by Electrolux are not covered by this warranty.
5. To the extent permitted by law, you will bear the cost of transportation, travel and delivery of the Appliance to and from Electrolux or its ASC. If you reside outside of the service area, you will bear the cost of:
  - a) travel of an authorised representative;
- g) 'Warranty Period' means the Appliance is warranted against manufacturing defects in Australia and New Zealand for 60 months, following the date of original purchase of the Appliance;
- h) 'you' means the purchaser of the Appliance not having purchased the Appliance for re-sale, and 'your' has a corresponding meaning.

- b) transportation and delivery of the Appliance to and from Electrolux or its ASC.
- In all instances, unless the Appliance is transported by Electrolux or an AEG authorised representative, the Appliance is transported at the owner's cost and risk while in transit to and from Electrolux or its ASC.
6. Proof of purchase is required before you can make a claim under this warranty.
  7. You may not make a claim under this warranty unless the defect claimed is due to faulty or defective parts or workmanship. Electrolux is not liable in the following situations (which are not exhaustive):
    - a) the Appliance is damaged by:
      - accident
      - misuse or abuse, including failure to properly maintain or service
      - normal wear and tear
      - power surges, electrical storm damage or incorrect power supply
      - incomplete or improper installation
      - incorrect, improper or inappropriate operation
      - insect or vermin infestation
      - failure to comply with any additional instructions supplied with the Appliance;
    - b) the Appliance is modified without authority from Electrolux in writing;
    - c) the Appliance's serial number or warranty seal has been removed or defaced;
    - d) the Appliance was serviced or repaired by anyone other than Electrolux, an authorised repairer or ASC.
  8. This warranty, the contract to which it relates and the relationship between you and Electrolux are governed by the law applicable where the Appliance was purchased. Where the Appliance was purchased in New Zealand for commercial purposes the Consumer Guarantee Act does not apply.
  9. To the extent permitted by law and subject to your non-excludable statutory rights and warranties, AEG excludes all warranties and liabilities (other than as contained in this document) including liability for any loss or damage whether direct or indirect arising from your purchase, use or non use of the Appliance.
  10. For AEG Appliances and services in Australia, the Appliances come with a guarantee that cannot be excluded under the ACL. You are entitled to a replacement or refund for a major failure and for compensation for any other reasonably foreseeable loss or damage. You are also entitled to have the Appliance repaired or replaced if the Appliance fails to be of acceptable quality and the failure does not amount to a major failure. The benefits to you given by this warranty are in addition to your other rights and remedies under a law in relation to the Appliances or services to which the warranty relates.
  11. At all times during the Warranty Period, Electrolux shall, at its discretion, determine whether repair, replacement or refund will apply if an Appliance has a valid warranty claim applicable to it.
  12. For Appliances and services provided in New Zealand, the Appliances come with a guarantee pursuant to the provisions of the Consumer Guarantees Act, the Sale of Goods Act and the Fair Trading Act.
  13. To enquire about claiming under this warranty, please follow these steps:
    - a) carefully check the operating instructions, user manual and the terms of this warranty;
    - b) have the model and serial number of the Appliance available;
    - c) have the proof of purchase (e.g. an invoice) available;
    - d) telephone the numbers shown below.
  14. You accept that if you make a warranty claim, Electrolux and its ASC may exchange information in relation to you to enable Electrolux to meet its obligations under this warranty.



**Important Notice**

Before calling for service, please ensure that the steps listed in clause 13 above have been followed.

**SERVICE AUSTRALIA**

[www.aeg.com/au](http://www.aeg.com/au)

**FOR SERVICE**

or to find the address of your nearest state service centre in Australia

**PLEASE CALL 1300 363 664**

**OR EMAIL [customercare@aegaustralia.com.au](mailto:customercare@aegaustralia.com.au)**

For the cost of a local call (Australia only)

**FOR SPARE PARTS**

or to find the address of your nearest state spare parts centre in Australia

**PLEASE CALL 13 13 50**

**OR EMAIL [customercare@aegaustralia.com.au](mailto:customercare@aegaustralia.com.au)**

For the cost of a local call (Australia only)

**AEG SERVICE NEW ZEALAND**

[www.aeg.co.nz](http://www.aeg.co.nz)

**FOR SERVICE**

or to find the address of your nearest authorised service centre in New Zealand

**FREE CALL 0800 10 66 10**

**OR EMAIL [customercare@electrolux.co.nz](mailto:customercare@electrolux.co.nz)**

(New Zealand only)

**FOR SPARE PARTS**

or to find the address of your nearest state spare parts centre in New Zealand

**FREE CALL 0800 10 66 20**

**OR EMAIL [customercare@electrolux.co.nz](mailto:customercare@electrolux.co.nz)**

(New Zealand only)

## 10. ENVIRONMENTAL CONSIDERATIONS

Recycle materials that carry this symbol . Dispose of the packaging in special containers for recycling. Help protect the environment and human health and recycle waste deriving from electric and electronic devices.

Do not dispose of appliances that carry this symbol  together with domestic waste. Return the product to your local recycling facility or contact your municipal office.

# TABLE DES MATIÈRES

1. CONSIGNES FONDAMENTALES DE SÉCURITÉ.....	19
2. INSTRUCTIONS POUR LA SÉCURITÉ.....	20
3. DESCRIPTION DU PRODUIT.....	22
4. TABLEAU DE COMMANDE.....	22
5. PRÉPARATION À LA PREMIÈRE UTILISATION.....	23
6. UTILISATION QUOTIDIENNE.....	23
7. NETTOYAGE ET ENTRETIEN.....	28
8. RÉOLUTION DES PROBLÈMES.....	29
9. CONSIDÉRATIONS SUR L'ENVIRONNEMENT.....	31

## POUR DES RÉSULTATS PARFAITS

Merci d'avoir choisi ce produit AEG. Nous l'avons créé pour vous offrir des performances irréprochables pour longtemps, avec des technologies innovantes qui vous simplifient la vie - autant de caractéristiques que vous ne trouverez pas forcément sur les appareils ordinaires. Veuillez prendre quelques instants pour lire cette notice afin d'utiliser au mieux votre appareil électroménager.

**Visitez notre site Internet pour:**



Recevoir des conseils, télécharger nos brochures, éliminer d'éventuelles anomalies, obtenir des informations sur l'assistance :

**[www.aeg.com](http://www.aeg.com)**



Enregistrer vos produit et recevoir un meilleur service :

**[www.aeg.com/productregistration](http://www.aeg.com/productregistration)**



Acheter des accessoires, matériels de consommation et pièces de rechange originales pour votre appareil :

**[www.aeg.com/shop](http://www.aeg.com/shop)**

## SERVICE CLIENTS ET ENTRETIEN

Nous vous conseillons d'utiliser des pièces de rechange d'origine. Lorsqu'on contacte le Centre d'Assistance agréé, s'assurer de disposer des données suivantes : Modèle, PNC, numéro de série. Les informations se trouvent sur la plaque des données.

 Mise en garde/Attention - Informations importantes en matière de sécurité.

 Informations et conseils généraux.

 Informations sur l'environnement.

Sous réserve de modifications.

# 1. ⚠️ CONSIGNES FONDAMENTALES DE SÉCURITÉ

Lire attentivement les instructions fournies avant d'installer et d'utiliser l'appareil. Le fabricant n'est pas responsable si une installation et une utilisation non correcte de l'appareil provoquent des lésions et des dommages. Garder toujours les instructions à portée de main comme référence future.

## 1.1 Sécurité des enfants et des personnes vulnérables

- Cet appareil peut être utilisé par des enfants de plus de 8 ans et par des adultes ayant des capacités physiques, sensorielles ou mentales limitées ou ayant une expérience ou connaissance insuffisante sur l'utilisation de l'appareil, seulement s'ils sont surveillés ou instruits relativement à l'utilisation de l'appareil et s'ils ont compris les risques impliqués.
- Ne pas permettre aux enfants de jouer avec l'appareil.
- Garder les matériaux d'emballage hors de portée des enfants.
- Tenir les enfants et les animaux domestiques éloignés de l'appareil pendant le fonctionnement.
- Le nettoyage et les interventions d'entretien ne doivent pas être effectués par des enfants sans supervision.
- Tenir les enfants de moins de 3 ans éloignés s'ils ne sont pas constamment surveillés.

## 1.2 Mises en garde de sécurité générales

- L'installation de l'appareil et le remplacement des câbles doivent être effectués uniquement par du personnel qualifié.
- Avant d'effectuer toute intervention d'entretien, déconnecter l'appareil du réseau électrique.
- Ne pas utiliser de nettoyeur vapeur pour nettoyer l'appareil.
- Ne pas utiliser de détergents abrasifs ni de raclette en métal pour nettoyer l'appareil.

- Si le câble d'alimentation est endommagé, il doit être remplacé par le fabricant, un technicien autorisé ou une personne qualifiée, pour éviter des situations de danger.

## 2. INSTRUCTIONS POUR LA SÉCURITÉ

### 2.1 Installation



#### **ATTENTION !**

L'installation de l'appareillage doit être effectuée par du personnel qualifié.

- Ôter tous les matériaux d'emballage.
- Ne pas installer ni utiliser l'appareil s'il est endommagé.
- Se conformer aux instructions fournies avec l'appareil.
- Faire toujours attention en phase de déplacement de l'appareil. Toujours porter des gants de sécurité.
- Ne pas retourner ni incliner l'appareil ! Cela fera sortir l'huile de la pompe, ce qui pourrait endommager l'appareil.
- Il est nécessaire de respecter la distance minimum des autres appareils.
- S'assurer que l'appareil soit installé et adéquatement ancré à une structure fixe.
- Les côtés de l'appareil doivent rester adjacents à des appareils ou unités ayant la même hauteur.
- Ne pas utiliser de prises multiples ni de rallonges.
- S'assurer de ne pas endommager la prise ni le câble. Si le câble électrique doit être remplacé, l'intervention devra être effectuée par notre Centre d'Assistance.
- Les dispositifs de protection contre les décharges électriques doivent être fixés de telle à ne pas pouvoir être désactivés sans outils.
- Insérer la fiche d'alimentation dans la prise seulement à la fin de l'installation.
- Si la fiche de courant est desserrée, ne pas la relier à la prise.
- Ne pas tirer sur le câble d'alimentation pour débrancher l'appareil. Tirer seulement la fiche.
- Se servir uniquement de dispositifs d'isolation adéquats : interrupteurs automatiques, fusibles (ceux à bouchon doivent être ôtés du porte-fusible), déclencheurs pour courants de panne à la terre et relais.
- Le circuit électrique doit être doté d'un dispositif d'isolation permettant de déconnecter l'appareil de la prise de courant à tous les pôles. Le dispositif d'isolation doit avoir une largeur de l'ouverture de contact non inférieure à 3 mm.
- Cet appareil est conforme aux directives CEE.

### 2.2 Raccordement électrique



#### **ATTENTION !**

Risque d'incendie et de décharge électrique.

- Tous les raccordements électriques doivent être réalisés par un électricien qualifié.
- L'appareil doit disposer d'une mise à la terre.
- S'assurer que les données électriques reportées sur la plaque des données correspondent à celles de l'installation. Dans le cas contraire, contacter un électricien.
- Utiliser toujours une prise électrique avec contact de protection correctement installée.

## 2.3 Utilisation



### ATTENTION !

Risque de lésions, brûlures, décharges électriques ou explosions.

- Ne pas toucher la barre de soudure après l'utilisation. La chaleur résiduelle peut causer des brûlures.
- Utiliser l'appareil exclusivement dans un environnement domestique.
- Ne pas apporter de modifications aux spécifications de cet appareil.
- Ne jamais laisser l'appareil sans surveillance pendant le fonctionnement.
- Éteindre l'appareil après chaque utilisation.
- Ne pas mettre en marche l'appareil avec les mains humides ou s'il y a un contact avec de l'eau.
- Ne pas exercer de pression sur le tiroir.
- Ne pas utiliser l'appareil comme surface de travail ou comme plan d'appui.
- Éviter la présence d'étincelles ou de flammes ouvertes près de l'appareil lorsqu'on ouvre le tiroir.
- Ne pas poser ni laisser de liquides ou matériaux inflammables, ni d'objets facilement inflammables sur l'appareil, à l'intérieur ou à proximité.



### ATTENTION !

Il y a le risque d'endommager l'appareil.

- Faire attention lorsqu'on enlève ou insère les accessoires.
- Ne pas forcer l'ouverture du couvercle pendant le cycle de travail.

- Ne pas forcer l'ouverture du couvercle pendant le cycle de travail en l'absence d'énergie électrique.
- N'appuyer aucun poids sur le couvercle.
- Éviter de faire tomber un objet sur le couvercle ! Cela pourrait altérer son intégrité, en causant des fissures ou une rupture.

## 2.4 Nettoyage et entretien



### ATTENTION !

Il y a le risque de lésions, d'incendie ou de dommages à l'appareil.

- Avant d'effectuer toute intervention d'entretien, éteindre l'appareil et extraire la fiche de la prise.
- Contrôler que l'appareillage soit froid.

## 2.5 Élimination



### ATTENTION !

Risque de lésions ou étouffement.

- Détacher la fiche de l'alimentation électrique.
- Couper le câble de réseau et l'éliminer.

## 2.6 Assistance technique

- Pour réparer l'appareil, contacter le Centre d'Assistance autorisé.
- Utiliser exclusivement des pièces de rechange originales.

### 3. DESCRIPTION DU PRODUIT

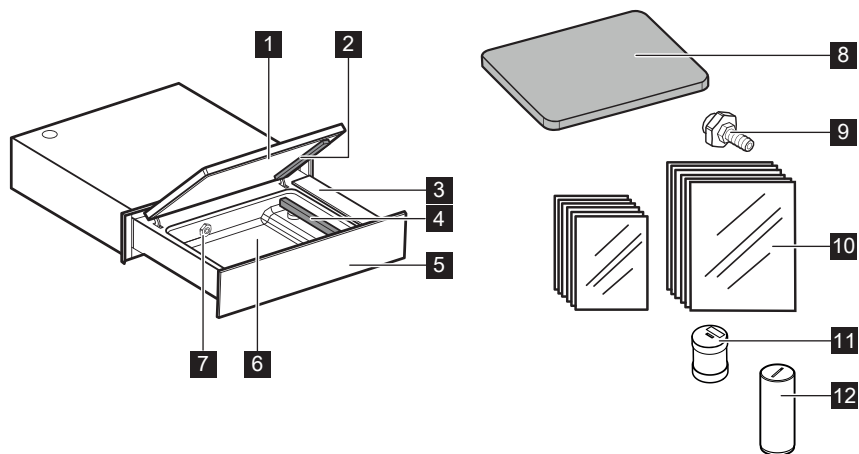

- 1** Couvercle
- 2** Coussin d'étanchéité
- 3** Panneau de commandes
- 4** Barre de soudure
- 5** Panneau avant
- 6** Cuve
- 7** Buse d'aspiration
- 8** Plaque de remplissage
- 9** Raccord pour sous-vide extérieur
- 10** Sachets pour surgélation, cuisson et conservation  
N. 25 20x30 cm  
N. 25 25x35 cm
- 11** Filtre à huile
- 12** Bouchon

### 4. TABLEAU DE COMMANDE

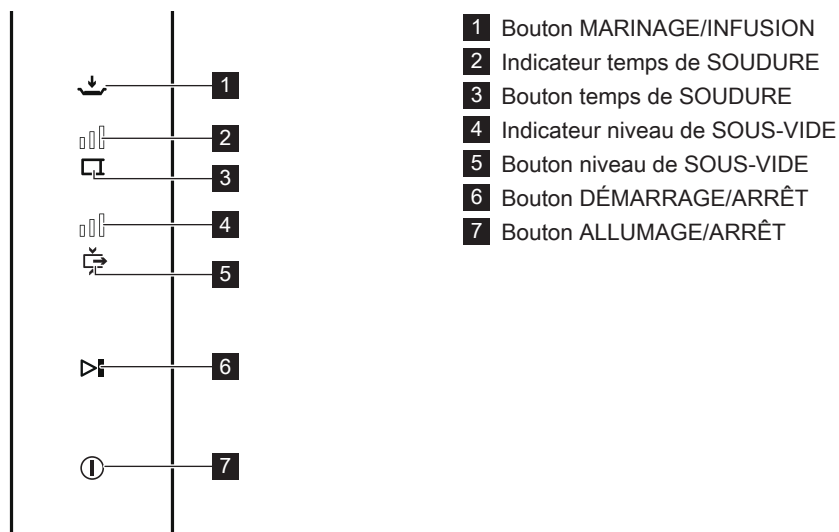

- 1** Bouton MARINAGE/INFUSION
- 2** Indicateur temps de SOUDURE
- 3** Bouton temps de SOUDURE
- 4** Indicateur niveau de SOUS-VIDE
- 5** Bouton niveau de SOUS-VIDE
- 6** Bouton DÉMARRAGE/ARRÊT
- 7** Bouton ALLUMAGE/ARRÊT

## 5. PRÉPARATION À LA PREMIÈRE UTILISATION



### ATTENTION !

Se référer aux chapitres sur la sécurité.



### ATTENTION !

Introduire l'huile dans la machine avant l'installation.



### ATTENTION !

Se conformer aux instructions fournies avec l'appareil.



### ATTENTION !

Le bouchon en plastique **12**, extrait en phase d'installation, doit être conservé pour de futures interventions d'assistance.

### 5.1 Premier nettoyage

- Se référer au chapitre « NETTOYAGE ET ENTRETIEN ».
- Nettoyer avec un chiffon humide toutes les parties avant la première utilisation.

### 5.2 Première utilisation

Allumer l'appareil en pressant pendant au moins 1 seconde le bouton .















Seul le bouton  clignote, exécuter la procédure de déblocage (voir les instructions d'installation - phase 13). Autrement, exécuter un cycle de reconditionnement de l'huile, comme indiqué au par. 6.6.





## 6. UTILISATION QUOTIDIENNE

Ce produit est idéal pour :

- Conditionnement d'aliments sous-vide pour cuisson à basse température « Sous-Vide ».
- Conditionnement d'aliments sous-vide pour conservation.
- Marinage/infusion d'aliments.

Bouton	Description	Fonction	
	Bouton ALLUMAGE/ ARRÊT	Pour allumer/éteindre l'appareil.	
	Bouton DÉMARRAGE/ ARRÊT	Pour démarre/arrêter le cycle de conditionnement.	
	Bouton SOUS-VIDE	Pour configurer un des 4 niveaux sous- vide disponibles. La valeur pré- configurée est MAX.	 uniquement soudure
		 MIN.	
		 MOY.	
		 MAX.	
	Bouton SOUDURE	Pour configurer le temps de soudure sur la base de l'épaisseur du sachet <sup>1)</sup> . L'appareil est pré- configuré sur 2,5 s, temps idéal pour les sachets fournis.	 désactivée
		 1,5 s	
		 2,5 s	
		 4,0 s	
	Bouton MARINAGE/ INFUSION	Pour activer la fonction de marinage/infusion.	



<sup>1)</sup> Plus le sachet est épais, plus long sera le temps à configurer.

- Extraire le tiroir jusqu'à l'ouverture maximum.
  - Allumer l'appareil en pressant pendant au moins 1 seconde le bouton .
  - Modifier, si nécessaire, le niveau de sous-vide et le temps de soudure.
  - Soulever le couvercle et positionner dans la cuve, le sachet avec à l'intérieur l'aliment à conditionner en laissant au moins 2 cm au-delà de la barre de soudure.
  - Pour garantir une soudure parfaite, il est important de ne pas salir le sachet dans la zone où se produit la soudure. Pour cela, il est conseillé de replier le côté interne du sachet vers l'extérieur sur 4/5 cm. L'aliment inséré, replier le sachet dans la condition initiale.
  - Pour des produits peu volumineux, utiliser la tablette de remplissage fournie puisqu'elle favorise une meilleure position du sachet par rapport à la barre de soudure.
  - Fermer le couvercle en exerçant une légère pression et presser le bouton  qui commence à clignoter. Ainsi, le cycle de conditionnement commencera.
  - À la fin du cycle, ce bouton arrêtera de clignoter.
  - Ouvrir le couvercle et extraire le sachet.
-  Ne pas toucher la barre de soudure après l'utilisation. La chaleur résiduelle peut causer des brûlures.
- Éteindre l'appareil en maintenant pressé le bouton .
-  Si l'appareil reste inutilisé pendant 60 minutes, il s'éteint automatiquement.







### Aliments liquides

Si, pendant le fonctionnement, on presse le bouton , le cycle s'arrête et la soudure du sachet est immédiatement effectuée. Cette procédure doit être utilisée si on conditionne des produits liquides qui, pendant le cycle de sous-vide, peuvent aller en ébullition.

 Remarque : Périodiquement, l'appareil exécute en mode automatique un cycle de reconditionnement (voir le par. 6.6) durant lequel, les boutons  et  clignotent. Laisser le cycle s'exécuter sans intervenir sur l'appareillage jusqu'à ce que les 2 boutons cessent de clignoter.

Selon l'aliment à conditionner, il est conseillé de configurer le niveau de sous-vide, comme indiqué dans le tableau :

Niveau de sous-vide 	Utilisation
	Conditionner, diviser en portions sans la création de sous-vide. <sup>1)</sup>
	Conditionner, diviser en portions des aliments particulièrement délicats (salade, tomates, etc.) avec niveau minimum de sous-vide (MIN).
	<ul style="list-style-type: none"> <li>- Conditionner, diviser en portions des aliments particulièrement délicats (légumes cuits, fruits, viandes tendres, pâtes) et des aliments liquides (soupes, crèmes, sauces).</li> <li>- Mariner en sachet.</li> <li>- Cuire Sous-vide (SousVide) des aliments délicats (par ex. du poisson) avec le niveau moyen de sous-vide (MOY).</li> </ul>
	<ul style="list-style-type: none"> <li>- Conditionner, diviser en portions des aliments solides (légumes crus, fromages à pâte dure, charcuterie coupée en tranche).</li> <li>- Cuire Sous-vide (SousVide) des aliments solides (par ex. viandes, pommes de terre, carottes, etc.) avec le niveau maximum de sous-vide (MAX).</li> <li>- Fermeture hermétique de bocaux en verre (voir par. 6.5).</li> </ul>

<sup>1)</sup> Avec cette fonction, on génère de toute façon une dépression minimum à l'intérieur du sachet.

## 6.1 Utilisation des sachets

Les sachets fournis sont idéals pour la surgélation, la conservation et la cuisson d'aliments sous-vide à basses températures.

### Code pour la commande de sachets : 902979704

50 sachets pour surgélation, cuisson sous-vide et conservation  
(25 pièces dimension : 20x30 cm + 25 pièces dimension 25x35 cm)

### Code pour la commande de sachets : 9029794014

50 sachets pour cuisson sous-vide et conservation  
(25 pièces dimension : 20x30 cm + 25 pièces dimension 25x35 cm)



Il est recommandé d'utiliser des sachets originaux.

[www.aeg.com/shop](http://www.aeg.com/shop)

## 6.2 Conditionnement d'aliments sous-vide pour cuisson à basse température « SousVide »

Cette technique prévoit que les aliments scellés dans le sachet sous-vide soient ensuite cuits lentement à des basses températures.

### Les avantages sont innombrables :

- Le goût et la consistance des aliments restent inaltérés.
- Les goûts et les parfums sont préservés, et les arômes ne sont pas perdus pendant la cuisson.
- La moindre perte de liquides rend les aliments plus moelleux et moins secs.
- Les propriétés nutritives, comme les Sels minéraux et les vitamines, sont préservées dans l'aliment.
- Il n'est pas nécessaire d'ajouter de l'huile ni du graissage pour la cuisson.

## 6.3 Conditionnement d'aliments sous-vide pour conservation

Le conditionnement sous-vide rallonge les durées de conservation des aliments. Si on veut conditionner sous-vide des aliments qui viennent d'être cuits, ceux-ci doivent d'abord refroidir, si possible au moyen d'une cellule de refroidissement.

## 6.4 Marinage/Infusion

- Placer dans un plat à rôti/plat l'aliment avec la marinade d'arômes.
- Allumer l'appareil en pressant pendant au moins 1 seconde le bouton .
- Soulever le couvercle et positionner le plat dans la cuve.
- Presser le bouton qui commencera à clignoter.
- Fermer le couvercle en exerçant une légère pression.
- Presser le bouton pour commencer le cycle de marinage. Ce bouton commencera à clignoter.
- À la fin du cycle de marinage, ce bouton cessera de clignoter.
- Il sera alors possible d'ouvrir le couvercle et d'enlever le plat.

Le cycle de marinage et d'infusion a un temps pré-configuré de 8 minutes. Pour augmenter l'infusion, répéter le cycle.

Cette infusion peut être désactivée à tout instant en pressant le bouton .



Il est également possible d'effectuer le marinage des aliments directement dans un sachet.

Dans ce cas, configurer le niveau de sous-vide selon vos besoins.

## 6.5 Fonctions supplémentaires

### « Fermeture hermétique de bocaux en verre »

C'est la fonction à utiliser pour fermer hermétiquement les bocaux en verre à utiliser pour bocal-cuissons ou pour augmenter le temps de conservation du produit contenu (bocaux pas fournis avec cet appareil).

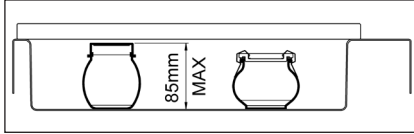

- Configurer le niveau maximum du vide et désactiver la soudure .
- Fermer le bocal avec une légère pression et l'insérer dans la cuve, fermer le couvercle en appuyant légèrement, puis appuyer sur le bouton qui commence à clignoter. Ainsi, le cycle de conditionnement commencera.
- À la fin du cycle, ce bouton arrêtera de clignoter.

### « Sous-vide extérieur »

C'est la fonction à utiliser pour l'élimination de l'air à l'intérieur de récipients spéciaux, hermétiquement refermables (pas fournis avec cet appareil).

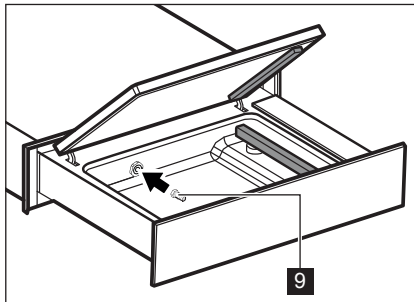

- Pour le sous-vide extérieur, visser le raccord **9** fourni, à l'intérieur de la cuve.

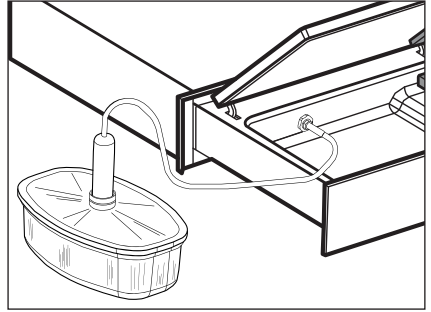

- Relier le tuyau du récipient au raccord **9**.
- Configurer le niveau maximum du vide et désactiver la soudure .
- Avec le couvercle de l'appareil ouvert, presser le bouton pour démarrer le cycle de conditionnement. Ce bouton commencera à clignoter.
- À la fin du cycle, ce bouton arrêtera de clignoter.

## 6.6 Cycle de reconditionnement

C'est la fonction à utiliser dans les situations suivantes :

- Avant d'utiliser l'appareil pour la première fois.
- Après un arrêt prolongé.
- Après avoir emballé les produits avec un pourcentage d'humidité élevé (ex. potages et soupes).
- Lorsque l'on remarque une baisse des performances de l'appareil (ex. : le temps pour atteindre le sous-vide augmente ou ne l'atteint pas).





Ce programme, qui dure environ 15 minutes, garantit un nettoyage complet de la pompe en éliminant toute émulsion de liquides pouvant se former dans l'huile.

Pendant l'exécution de ce programme, aucun produit ne doit être emballé.

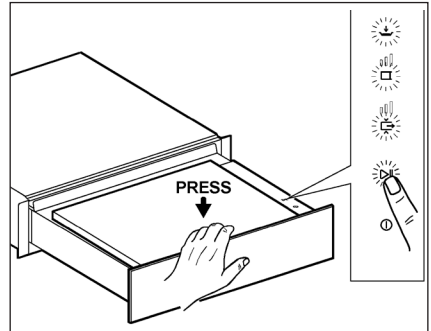
Procéder comme indiqué ci-dessous :

- Maintenir pressé le bouton  jusqu'à ce que tous les boutons clignotent.



- Fermer le couvercle en exerçant une légère pression.
- Presser le bouton . Pendant l'exécution du programme, les boutons  et  clignotent.
- À la fin du cycle (15 minutes), le bouton  arrêtera de clignoter et l'appareil sera prêt être utilisé.

## 7. NETTOYAGE ET ENTRETIEN



### ATTENTION !

Se référer aux chapitres sur la sécurité.

- Nettoyer l'appareil après chaque utilisation avec un chiffon humidifié et doux.

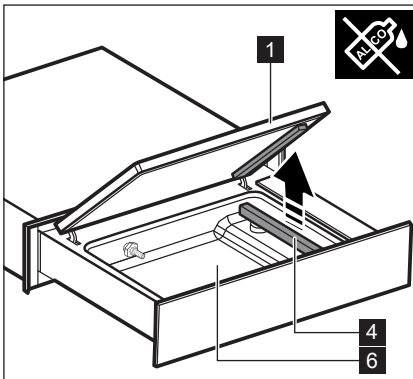

- Pour le nettoyage du couvercle en plexiglass **1** nettoyer aussi bien l'extérieur que l'intérieur, exclusivement avec des détergents neutres (eau et savon).
- Ne pas utiliser de produits abrasifs, de détergents à base d'alcool, de petites éponges abrasives, de solvants ni d'objets métalliques.
- Si on utilise des produits pour le nettoyage de la cuve en acier **6**, se conformer aux instructions de sécurité indiquées sur l'emballage.
- Pour le nettoyage de la cuve **6**, surtout en cas de résidus liquides, il est conseillé d'extraire vers le haut la barre de soudure **4**.
- Nettoyer la barre de soudure **4** avec un chiffon sec. Ôter d'éventuels résidus qui se déposent sur la barre.
- Nettoyer les surfaces métalliques avec des détergents normaux pour l'acier inox.
- Laisser le panneau de commande propre et sec.



## 8. RÉOLUTION DES PROBLÈMES



### ATTENTION !











Se référer aux chapitres sur la sécurité.

### 8.1 Que faire, si...

Problème	Cause possible	Solution
Le sachet n'est pas correctement soudé.	Le temps de soudure n'est pas correct.	Modifier le temps de soudure.
	Le joint du couvercle est sale ou usé.	Nettoyer ou remplacer le joint du couvercle (pour le remplacement, s'adresser à l'Assistance Technique).
	Le sachet n'est pas correctement placé sur la barre de soudure.	Placer le sachet correctement.
	La barre de soudure est usée (le revêtement en téflon est brûlé).	Remplacer la barre de soudure (pour le remplacement, s'adresser à l'Assistance Technique).
Sous-vide final insuffisant.	La lame située sous le téflon de la barre de soudure est cassée.	Remplacer la lame (pour le remplacement, s'adresser à l'Assistance Technique).
	Le niveau de sous-vide configuré n'est pas correct.	Modifier le niveau de sous-vide.
	Le joint du couvercle est sale ou usé.	Nettoyer ou remplacer le joint du couvercle (pour le remplacement, s'adresser à l'Assistance Technique).
	Le couvercle n'est pas correctement fermé.	Fermer correctement le couvercle. S'assurer qu'il n'y ait pas d'objets ni de saleté entre le couvercle et la cuve.
Le couvercle n'ouvre pas.	Impuretés présentes dans l'huile de la pompe.	Exécuter un « cycle de reconditionnement » de l'huile (voir par. 6.6).
	Absence d'électricité.	Attendre le rétablissement de l'électricité.
	Couvercle endommagé.	Remplacer la lame (pour le remplacement, s'adresser à l'Assistance Technique).
Le couvercle présente des fissures ou ruptures.		
Les boutons  et  clignotent.	« Cycle de reconditionnement » en cours.	Attendre la fin du « cycle de reconditionnement » (15 minutes).

Lors de la mise hors tension de la machine, la pompe démarre.	Le « Cycle de reconditionnement » de l'huile périodique a été lancé (voir par. 6.6).	Attendre la fin du « cycle de reconditionnement » (15 minutes).
Le cycle du vide commence, en activant la pompe à vide, mais s'arrête en quelques secondes et le bouton clignote  (sans avoir éliminé l'air dans le bocal ni avoir soudé le sachet).	Le couvercle n'a pas été fermé correctement.	Exercer une légère pression sur le couvercle pour permettre la fermeture hermétique du joint.
	Le joint du couvercle est sale ou usé.	Nettoyer le joint. Remplacer le joint.

### Messages d'alarme

Alarme	Cause possible	Solution
Le bouton  clignote continuellement.	La carte électrique est en panne.	Contacter l'Assistance Technique.
Le bouton  clignote continuellement.	Sous-vide pas atteint.	Nettoyer ou remplacer le joint du couvercle (pour le remplacement, s'adresser à l'Assistance Technique). Contrôler que le couvercle se ferme correctement. Presser le bouton  pour réinitialiser l'alarme.
Les boutons  et  clignotent continuellement.	L'huile de la pompe doit être changée.	Contacter l'Assistance Technique.
Le bouton  clignote continuellement.	Le cycle de conditionnement s'est terminé avant parce qu'on conditionne un produit humide.	Presser le bouton  pour réinitialiser l'alarme.
Seul le bouton  clignote continuellement.	La machine est en mode « premier démarrage » (voir les instructions d'installation – phase 13).	Fermer le couvercle en exerçant une légère pression et appuyer sur le bouton  . Tous les boutons s'allument et le cycle de reconditionnement de l'huile démarre (les boutons  et  clignotent). Attendre 15' pour l'achèvement de la procédure.

## 8.2 Données de l'Assistance

S'il n'est pas possible de trouver une solution au problème, contacter le Centre d'Assistance Technique autorisé.

Les informations nécessaires pour le Centre d'Assistance Technique se trouvent sur la plaque des données, située sur le côté gauche de l'appareil. Ne pas ôter la plaque des données.

# 9. CONSIDÉRATIONS SUR L'ENVIRONNEMENT

Recycler les matériaux ayant le symbole .  
Jeter l'emballage dans les conteneurs prévus pour le recyclage. Aider à protéger l'environnement et la santé des hommes, et à recycler les déchets dérivant d'équipements électriques et électroniques.

Ne pas éliminer les appareils reportant le symbole  avec les déchets domestiques normaux.  
Porter le produit au point de recyclage le plus près ou contacter la mairie.

# INHALTSVERZEICHNIS

1. SICHERHEITSHINWEISE.....	33
2. SICHERHEITSANWEISUNGEN .....	34
3. BESCHREIBUNG DES PRODUKTS.....	36
4. BEDIENFELD .....	36
5. VORBEREITUNG FÜR DIE ERSTE VERWENDUNG .....	37
6. TÄGLICHE VERWENDUNG .....	37
7. REINIGUNG UND PFLEGE .....	42
8. PROBLEMLÖSUNG .....	43
9. UMWELTSCHUTZINFORMATIONEN .....	45

## FÜR PERFEKTE ERGEBNISSE

Danke, dass Sie sich für dieses AEG Produkt entschieden haben. Wir haben es geschaffen, damit Sie viele Jahre von seiner ausgezeichneten Leistung und den innovativen Technologien, die Ihnen das Leben erleichtern, profitieren können.

Es ist mit Funktionen ausgestattet, die in gewöhnlichen Elektrogeräten nicht vorhanden sind. Nehmen Sie sich ein paar Minuten Zeit zum Lesen, um seine Vorzüge kennen zu lernen.

**Besuchen Sie unsere Homepage, um:**



Tipps zu erhalten, unsere Dokumentation herunterzuladen, eventuelle Störungen zu beheben, Informationen in Bezug auf den Kundendienst zu erhalten:

**[www.aeg.com](http://www.aeg.com)**



Registrieren Sie Ihr Produkt, um immer den besten Service zu erhalten:

**[www.aeg.com/productregistration](http://www.aeg.com/productregistration)**



Für den Kauf von Zubehörteilen, Verbrauchsmaterial und Original-Ersatzteilen für Ihr Gerät:

**[www.aeg.com/shop](http://www.aeg.com/shop)**

## KUNDENSERVICE UND WARTUNG

Wir empfehlen immer die Verwendung von Original-Ersatzteilen.

Wenn Sie das autorisierte Kundendienstzentrum kontaktieren, sollten Sie die folgenden Daten bereithalten. Modell, PNC, Seriennummer.

Die Informationen finden Sie auf dem Schild mit den Daten.

 **Warnung/Achtung** - Wichtige Informationen für die Sicherheit.

 Informationen und allgemeine Ratschläge.

 Umweltschutzinformationen.

Änderungen vorbehalten.



# 1. ⚠ SICHERHEITSHINWEISE

Vor der Installation und der Verwendung des Geräts muss die Bedienungsanleitung aufmerksam gelesen werden. Der Hersteller übernimmt keine Haftung, wenn es durch eine unsachgemäße Installation und Verwendung des Geräts zu Verletzungen kommt. Die Bedienungsanleitung immer für zukünftiges Nachschlagen griffbereit aufbewahren.

## 1.1 Sicherheit von Kindern und schutzbedürftigen Personen

- Dieses Gerät kann von Kindern ab 8 Jahren sowie von Personen mit beeinträchtigten, körperlichen oder geistigen Fähigkeiten bzw. eingeschränkter Wahrnehmung oder ohne Erfahrung und Kenntnissen benutzt werden, wenn sie beaufsichtigt werden oder in die sichere Benutzung des Geräts eingewiesen wurden und wenn sie die sich daraus ergebenden Gefahren verstehen.
- Kinder dürfen nicht mit dem Gerät spielen.
- Die Verpackungsmaterialien immer außerhalb der Reichweite von Kindern halten.
- Kinder und Haustiere dürfen sich während des Betriebs nicht in der Nähe des Geräts aufhalten.
- Die Reinigungs- und Wartungstätigkeiten dürfen nicht von Kindern ohne Aufsicht ausgeführt werden.
- Kinder, die jünger als 3 Jahre sind, vom Gerät fernhalten, wenn sie nicht laufend überwacht werden.

## 1.2 Allgemeine Sicherheitshinweise

- Die Installation des Geräts und der Austausch der Kabel dürfen ausschließlich von Fachpersonal durchgeführt werden.
- Vor der Durchführung von Wartungstätigkeiten muss das Gerät immer vom Stromnetz getrennt werden.
- Für die Reinigung des Geräts keine Dampfreiniger verwenden.
- Keine scheuernden Reinigungsmittel oder Metallschaber für die Reinigung des Geräts verwenden.

- Wenn das Versorgungskabel beschädigt ist, muss es vom Hersteller, einem autorisierten Techniker oder einer qualifizierten Person ausgetauscht werden, um Gefahrensituationen zu vermeiden.

## 2. SICHERHEITSANWEISUNGEN

### 2.1 Installation



#### **ACHTUNG!**

Die Installation des Geräts muss von qualifiziertem Personal durchgeführt werden.

- Sämtliche Verpackungsmaterialien entfernen.
- Das Gerät nicht installieren oder verwenden, wenn es beschädigt ist.
- Die mit dem Gerät gelieferten Anleitungen beachten.
- Beim Umstellen des Geräts immer besondere Vorsicht walten lassen. Immer Sicherheitshandschuhe tragen.
- Das Gerät nicht umdrehen oder kippen! Dadurch tritt das Öl aus der Pumpe aus, wodurch das Gerät beschädigt werden könnte.
- Der Mindestabstand zu den anderen Geräten muss eingehalten werden.
- Sicherstellen, dass das Gerät korrekt installiert und entsprechend an einer fixen Konstruktion verankert ist.
- Die Seiten des Geräts müssen an Geräten oder Einheiten mit derselben Höhe angrenzen.

### 2.2 Stromanschluss



#### **ACHTUNG!**

Brand- und Stromschlaggefahr.

- Sämtlichen elektrischen Anschlüsse müssen von einem qualifizierten Elektriker hergestellt werden.
- Das Gerät muss geerdet werden.
- Sicherstellen, dass die auf dem Typenschild angeführten elektrischen Daten jenen der Anlage entsprechen. Andernfalls einen Elektriker zu Rate ziehen.
- Immer eine korrekt installierte Steckdose mit Schutzkontakt verwenden.
- Keine Mehrfachsteckdosen und Verlängerungskabel verwenden.
- Sicherstellen, dass der Stecker und das Kabel nicht beschädigt werden. Wenn das Stromkabel ausgetauscht werden muss, so ist dies von unserem Kundendienst vorzunehmen.
- Die Schutzvorrichtungen gegen Stromschläge müssen so angebracht werden, dass sie nicht ohne Hilfe von Werkzeug entfernt werden können.
- Den Versorgungsstecker nur nach Abschluss der Installation in die Steckdose einstecken.
- Sollte der Stecker gelockert sein, darf er nicht in die Steckdose eingesteckt werden.
- Zum Trennen des Geräts von der Stromversorgung niemals am Versorgungskabel ziehen. Ausschließlich am Stecker ziehen.
- Es dürfen ausschließlich angemessene Isoliervorrichtungen verwendet werden: Leitungsschutzschalter, Sicherungen (Stöpselsicherungen müssen aus der Sicherungshalterung entfernt werden), Erdschlussstrom-Auslöser und Relais.
- Die Elektroanlage muss über eine Isoliervorrichtung verfügen, mit der das Gerät mit allen Polen von der Steckdose getrennt werden kann. Die Isoliervorrichtung muss über eine Öffnungsweite des Kontakts von mindestens 3 mm verfügen.
- Dieses Gerät ist mit den EWG-Normen konform.

## 2.3 Gebrauch



### **ACHTUNG!**

Gefahr von Verletzungen, Verbrennungen, Stromschlägen oder Explosionen.

- Den Siegelbalken nach der Verwendung nicht berühren. Die Restwärme kann Verbrennungen verursachen.
- Das Gerät ausschließlich im Haushalt verwenden.
- Keine Änderungen an den Spezifikationen dieses Geräts vornehmen.
- Das Gerät während des Betriebs niemals unbeaufsichtigt lassen.
- Das Gerät nach jeder Verwendung ausschalten.
- Das Gerät niemals mit feuchten Händen oder wenn ein Kontakt mit Wasser vorliegt in Betrieb nehmen.
- Keinen Druck auf die Lade ausüben.
- Das Gerät nicht als Arbeits- oder Ablagefläche verwenden.
- Funkenbildung und offene Flammen in der Nähe des Geräts vermeiden, wenn die Lade geöffnet wird.
- Keine entflammaren Flüssigkeiten oder Materialien bzw. leicht entzündliche Gegenstände auf dem Gerät, in dem Gerät oder in unmittelbarer Nähe ablegen oder aufbewahren.



### **ACHTUNG!**

Das Gerät könnte dadurch beschädigt werden.

- Bei der Anbringung und Entfernung von Zubehöerteilen besondere Vorsicht walten lassen.
- Während des Arbeitszyklus den

Deckel nicht gewaltsam öffnen.

- Bei einem Stromausfall den Deckel während des Arbeitszyklus nicht gewaltsam öffnen.
- Kein Gewicht auf dem Deckel abstellen.
- Vermeiden, dass Gegenstände auf den Deckel fallen! Das könnte zu Beschädigungen führen und Risse oder den Bruch hervorrufen.

## 2.4 Reinigung und Pflege



### **ACHTUNG!**

Es besteht die Gefahr von Verletzungen, Brand oder Schäden am Gerät.

- Vor der Durchführung von Wartungstätigkeiten muss das Gerät immer ausgeschaltet und der Stecker gezogen werden.
- Sicherstellen, dass das Gerät abgekühlt ist.

## 2.5 Entsorgung



### **ACHTUNG!**

Gefahr von Verletzungen oder Ersticken.

- Den Stecker der Stromversorgung ziehen.
- Das Netzkabel abschneiden und entsorgen.

## 2.6 Technischer Kundendienst

- Für die Reparatur des Geräts eine autorisierte Kundendienststelle kontaktieren.
- Ausschließlich Originalersatzteile verwenden.

### 3. BESCHREIBUNG DES PRODUKTS

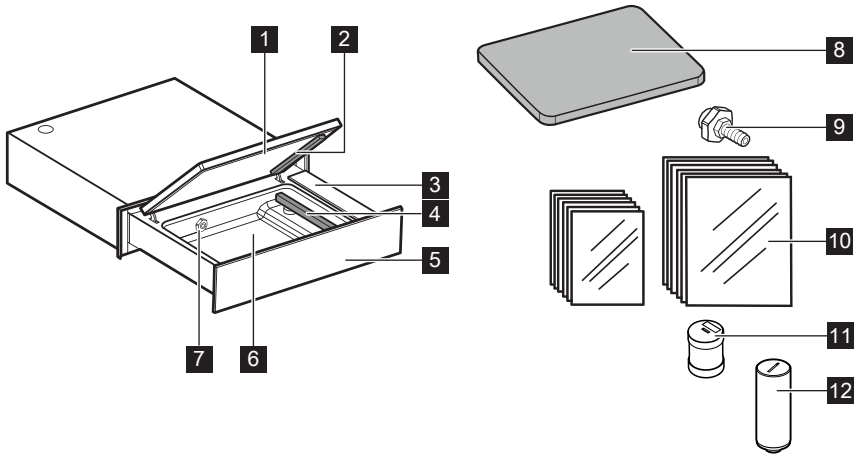

- |   |   |
|---|---|
| <ul style="list-style-type: none"> <li><b>1</b> Deckel</li> <li><b>2</b> Siegelkissen</li> <li><b>3</b> Bedienfeld</li> <li><b>4</b> Siegelbalken</li> <li><b>5</b> Frontpaneel</li> <li><b>6</b> Wanne</li> <li><b>7</b> Absaugdüse</li> </ul> | <ul style="list-style-type: none"> <li><b>8</b> Einlegeplatte</li> <li><b>9</b> Verbindungsstück für externes Vakuum</li> <li><b>10</b> Beutel zum Einfrieren, Garen und Aufbewahren<br/>25 St. 20x30 cm<br/>25 St. 25x35 cm</li> <li><b>11</b> Ölfilter</li> <li><b>12</b> Deckel</li> </ul> |
|---|---|

### 4. BEDIENFELD

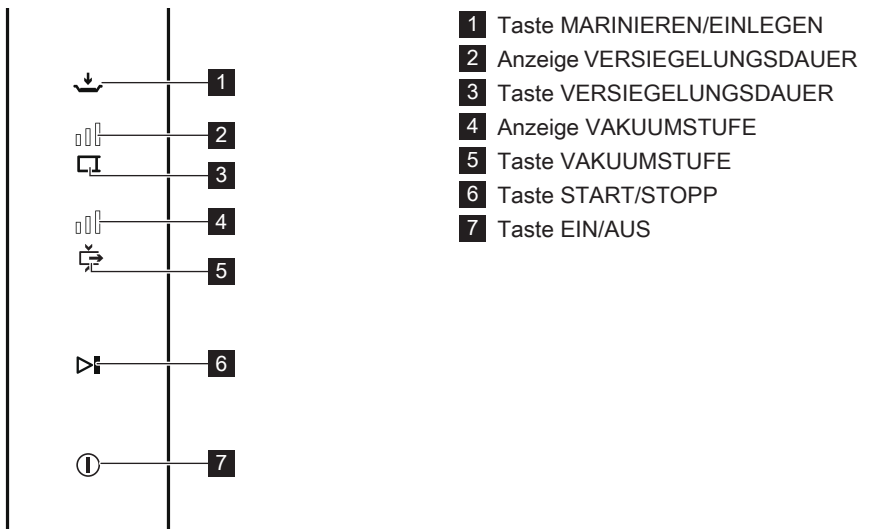

- 1** Taste MARINIEREN/EINLEGEN
- 2** Anzeige VERSIEGELUNGSDAUER
- 3** Taste VERSIEGELUNGSDAUER
- 4** Anzeige VAKUUMSTUFE
- 5** Taste VAKUUMSTUFE
- 6** Taste START/STOPP
- 7** Taste EIN/AUS

## 5. VORBEREITUNG FÜR DIE ERSTE VERWENDUNG



### ACHTUNG!

Die Kapitel in Bezug auf die Sicherheit berücksichtigen.



### ACHTUNG!

Das Gerät vor der Installation mit Öl füllen.



### ACHTUNG!

Die mit dem Gerät gelieferten Anleitungen beachten.



### ACHTUNG!

Der während der Installation entfernte Plastikverschluss **12** muss für zukünftige Eingriffe des Kundendienstes aufbewahrt werden.

### 5.1 Erste Reinigung

- Das Kapitel „REINIGUNG UND PFLEGE“ berücksichtigen.
- Vor der ersten Verwendung alle Teile mit einem feuchten Tuch reinigen.

### 5.2 Erste Verwendung

Das Gerät durch mindestens 1 Sekunde langes Drücken der Taste  einschalten.















Wenn nur die Taste  blinkt, die Freigabeprozedur durchführen (siehe Installationsanweisungen - Schritt 13).

Ansonsten einen Öl-Rekonditionierungszyklus entsprechend den Angaben in Abs. 6.6 durchführen.





## 6. TÄGLICHE VERWENDUNG

Dieses Produkt ist ideal geeignet für:

- Vakuumverpackung von Lebensmitteln für Garvorgänge bei niedrigen Temperaturen „SousVide“.
- Vakuumverpackung von Lebensmitteln für die Aufbewahrung.
- Marinieren/Einlegen von Lebensmitteln.



Taste	Beschreibung	Funktion	
	Taste EIN/AUS	Zum Ein-/Ausschalten des Geräts.	
	Taste START/ STOPP	Zum Starten/Anhalten des Verpackungszyklus.	
	Taste VAKUUM	Zur Einstellung einer der 4 verfügbaren Vakuumstufen. Der voreingestellte Wert lautet MAX.	 Nur Versiegelung
			 MIN.
			 MED.
			 MAX.
	Taste VERSIEGELUNG	Zur Einstellung der Versiegelungszeit auf Grundlage der Beutelstärke <sup>1)</sup> . Das Gerät ist auf 2,5 s voreingestellt, dieses Zeit ist optimal für die mitgelieferten Beutel geeignet.	 deaktiviert
			 1,5 s
			 2,5 s
			 4,0 s
	Taste MARINIEREN/ EINLEGEN	Zur Aktivierung der Funktion Marinieren/ Einlegen.	

1) Je stärker der Beutel ist, um so länger muss die Zeit eingestellt werden.





- Die Lade bis zur maximalen Öffnung herausziehen.
  - Das Gerät durch mindestens 1 Sekunde langes Drücken der Taste  einschalten.
  - Bei Bedarf die Vakuumstufe und die Versiegelungszeit ändern.
  - Den Deckel anheben und den Beutel mit den zu verpackenden Lebensmittel in der Wanne positionieren, dabei mindestens 2 cm nach dem Siegelbalken frei lassen.
  - Zur Gewährleistung einer optimalen Versiegelung darf der Beutel im Bereich, in dem die Versiegelung stattfindet nicht verschmutzt werden. Aus diesem Grund wird empfohlen, die Innenseite des Beutels auf einer Breite von 4-5 cm nach außen umzuschlagen. Nachdem die Lebensmittel in den Beutel gegeben wurden, diesen wieder in den Anfangszustand bringen.
  - Für nicht besonders voluminöse Produkte die mitgelieferte Einlegeplatte verwenden, da es eine optimale Positionierung des Beutels in Bezug auf den Siegelbalken gewährleistet.
  - Den Beutel schließen, dabei einen leichten Druck ausüben, anschließend die Taste  drücken, die zu blinken beginnt. Nun wird der Verpackungszyklus gestartet.
  - Nach Abschluss des Zyklus hört die Taste auf zu blinken.
  - Den Deckel öffnen und den Beutel entnehmen.
-  Den Siegelbalken nach der Verwendung nicht berühren. Die Restwärme kann Verbrennungen verursachen.
- Das Gerät ausschalten, dafür die Taste  gedrückt halten.
-  Wenn das Gerät 60 Minuten lang nicht verwendet wird, schaltet es sich automatisch aus.

### Flüssige Lebensmittel

Wenn während des Betriebs die Taste  gedrückt wird, hält der Zyklus an und es erfolgt unverzüglich die Versiegelung des Beutels. Dieser Vorgang ist zur Verpackung flüssiger Produkte, die während des Vakuumzyklus eventuell zu Sieden beginnen, zu benutzen.

 Hinweis: In regelmäßigen Abständen führt das Gerät automatisch einen Rekonditionierungszyklus durch (siehe Abs. 6.6), während dessen die Tasten  und  blinken. Die Ausführung des Zyklus abwarten, ohne Eingriffe am Gerät vorzunehmen, bis die beiden Tasten zu blinken aufhören.

Je nach zu verpackenden Lebensmitteln wird empfohlen, die Vakuumstufe gemäß folgender Tabelle einzustellen.

Vakuumstufe 	Gebrauch
	Verpacken, in Portionen aufteilen ohne Vakuumerzeugung. <sup>1)</sup>
	Verpacken, in Portionen aufteilen von besonders empfindlichen Lebensmitteln (Salat, Tomaten, etc.) mit der niedrigsten Vakuumstufe (MIN).
	<ul style="list-style-type: none"> <li>- Verpacken, in Portionen aufteilen von empfindlichen Lebensmitteln (gegartes Gemüse, Obst, zartes Fleisch, Teigwaren) und flüssigen Lebensmitteln (Suppen, Cremes, Saucen).</li> <li>- Marinieren im Beutel.</li> <li>- Vakuumgaren (SousVide) von empfindlichen Lebensmitteln (z.B. Fisch) mit der mittleren Vakuumstufe (MED.).</li> </ul>
	<ul style="list-style-type: none"> <li>- Verpacken, in Portionen aufteilen von festen Lebensmitteln (rohes Gemüse, Hartkäse, Wurstaufschnitt).</li> <li>- Vakuumgaren (SousVide) von festen Lebensmitteln (z.B. Fleisch, Kartoffeln, Karotten) mit der höchsten Vakuumstufe (MAX.).</li> <li>- Hermetischer Verschluss von Einmachgläsern (siehe Abs. 6.5).</li> </ul>

<sup>1)</sup> Mit dieser Funktion wird in jedem Fall ein minimaler Unterdruck im Beutel erzeugt.

## 6.1 Verwendung der Beutel

Die mitgelieferten Beutel sind optimal zum Einfrieren, Aufbewahren und Vakuumgaren von Lebensmitteln bei niedrigen Temperaturen geeignet.

### Code für die Bestellung der Beutel: 902979704

50 Beutel zum Einfrieren, Vakuumgaren und Aufbewahren  
(25 Stück Größe 20x30 cm + 25 Stück Größe 25x35 cm)

### Code für die Bestellung der Beutel: 9029794014

50 Beutel zum Vakuumgaren und Aufbewahren  
(25 Stück Größe 20x30 cm + 25 Stück Größe 25x35 cm)



Die Verwendung von Originalbeuteln wird empfohlen.

[www.aeg.com/shop](http://www.aeg.com/shop)

## 6.2 Vakuumverpackung von Lebensmitteln für Garvorgänge bei niedrigen Temperaturen „SousVide“

Diese Technik sieht einen langsamen Garvorgang der in versiegelten Beuteln vakuumverpackten Lebensmittel bei niedrigen Temperaturen vor.

### Es gibt zahlreiche Vorteile:

- Geschmack und Konsistenz der Lebensmittel bleiben unverändert.
- Geschmack und Duft werden beibehalten, da die Aromen während des Garvorgangs nicht verloren gehen.
- Dank des geringen Flüssigkeitsverlusts bleiben die Lebensmittel zarter und weniger trocken.
- Die Nährstoffe wie Mineralsalze und Vitamine bleiben im Lebensmittel erhalten.
- Für den Garvorgang müssen weder Öl noch Fett hinzugefügt werden.

## 6.3 Vakuumverpackung von Lebensmitteln für die Aufbewahrung

Die Vakuumverpackung verlängert die Aufbewahrungszeit der Lebensmittel. Für die Vakuumverpackung von soeben gegarten Lebensmitteln müssen sie zuerst tiefgekühlt werden, idealerweise mittels Schockkühlung.

## 6.4 Marinieren/Einlegen

- Die Lebensmittel mit der Marinade und den Aromen in eine Schale oder auf einen Teller legen.
- Das Gerät durch mindestens 1 Sekunde langes Drücken der Taste **1** einschalten.
- Den Deckel anheben und die Schale/ Teller in der Wanne positionieren.
- Die Taste  drücken, bis diese zu blinken beginnt.
- Den Deckel schließen, dabei einen leichten Druck ausüben.
- Zum Starten des Marinierzyklus die Taste **▶** drücken. Die Taste beginnt zu blinken.
- Die Taste hört auf zu blinken, sobald der Marinierzyklus abgeschlossen ist.
- Nun kann der Deckel geöffnet und die Schale/Teller entnommen werden.

Die Zeit für den Marinier- und Einlegezyklus ist auf 8 Minuten voreingestellt.

Zur Verlängerung des Einlegens, den Zyklus wiederholen.

Das Einlegen kann jederzeit durch Drücken der Taste **▶** deaktiviert werden.



Die Lebensmittel können auch direkt im Beutel mariniert werden. In diesem Fall muss die Vakuumstufe auf Grundlage der jeweiligen Anforderungen eingestellt werden.





## 6.5 Zusatzfunktionen

### „Hermetischer Verschluss von Einmachgläsern“

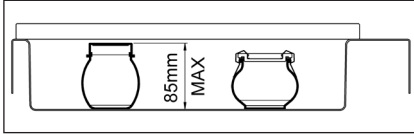
Diese Funktion dient, um Einmachgläser hermetisch zu verschließen, entweder, weil das Einmachgut darin gekocht wird, oder um Lebensmittel länger aufbewahren zu können (die Gefäße sind nicht im Lieferumfang dieses Geräts enthalten).



- Die maximale Vakuumstufe einstellen  und die Versiegelung deaktivieren .
- Das Einmachglas mit einem leichten Druck schließen und in die Wanne setzen, diese mit ihrem Deckel unter Ausübung eines leichten Drucks verschließen und Taste  drücken, die zu blinken beginnt. Nun wird der Verpackungszyklus gestartet.
- Nach Abschluss des Zyklus hört die Taste auf zu blinken.



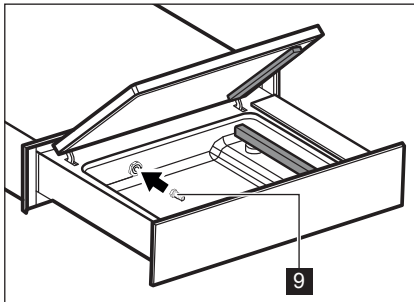

### „Externes Vakuum“

Diese Funktion wird zur Beseitigung von Luft aus speziellen hermetisch verschließbaren, wiederverwendbaren Behältern (die nicht im Lieferumfang des Geräts enthalten sind) verwendet.

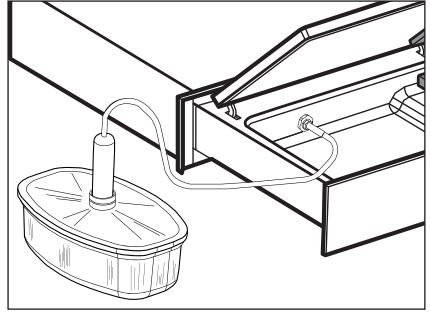

- Für das externe Vakuum, das mitgelieferte Verbindungsstück  in der Wanne anschrauben.



- Die Leitung des Behälters an das Verbindungsstück  anschließen.
- Die maximale Vakuumstufe einstellen  und die Versiegelung deaktivieren .
- Den Deckel des Geräts geöffnet lassen und die Taste  zum Starten des Verpackungszyklus drücken. Die Taste beginnt zu blinken.
- Nach Abschluss des Zyklus hört die Taste auf zu blinken.

## 6.6 Rekonditionierungszyklus

Diese Funktion muss in folgenden Situationen verwendet werden:

- Vor der ersten Verwendung des Geräts.
- Nach einem längeren Stillstand des Geräts.
- Nach der Verpackung von Produkten mit hohem Feuchtigkeitsgehalt (z.B. Suppen).
- Wenn ein Leistungsabfall des Geräts festgestellt wird (z.B. längere Zeit zum Erreichen des Vakuums erforderlich oder das Vakuum wird nicht erreicht).





Dieses Programm dauert etwa 15 Minuten und garantiert eine vollständige Reinigung der Pumpe und die Entfernung jeglicher Flüssigkeitsemulsion, die sich im Öl bilden kann.

Während der Ausführung dieses Programms dürfen keine Produkte verpackt werden.

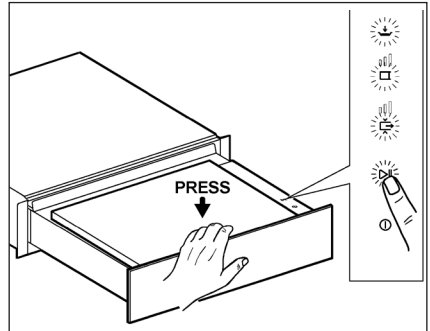
Wie im Anschluss beschrieben vorgehen:

- Die Taste  gedrückt halten bis alle Leuchttasten zu blinken beginnen.



- Den Deckel schließen, dabei einen leichten Druck ausüben.
- Die Taste  drücken. Während der Durchführung des Programms blinken die Tasten  und .
- Nach Abschluss des Zyklus (15 Minuten) hört die Taste  zu blinken auf und das Gerät ist zur Verwendung bereit.

## 7. REINIGUNG UND PFLEGE



### ACHTUNG!

Die Kapitel in Bezug auf die Sicherheit berücksichtigen.

- Das Gerät nach jeder Verwendung mit einem feuchten und weichen Tuch reinigen.

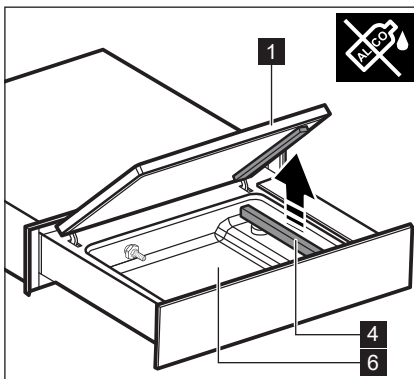

- Für die Reinigung des Plexiglasdeckels **1** sowohl die Außen- als auch die Innenseite

ausschließlich mit neutralen Mitteln reinigen (Wasser und Seife).

- Keinen scheuernden Produkte, Produkte auf Alkoholbasis, Scheuerschwämme, Lösungsmittel oder metallische Gegenstände verwenden.
- Wenn Produkte zur Reinigung der Stahlwanne **6** verwendet werden, müssen die Sicherheitshinweise auf der Verpackung eingehalten werden.
- Es wird empfohlen, für die Reinigung der Wanne **6**, vor allem bei Vorhandensein von Flüssigkeitsrückständen, den Siegelbalken **4** nach oben heraus zu ziehen.
- Den Siegelbalken **4** mit einem trockenen Tuch reinigen. Eventuelle Ablagerungen von Rückständen vom Siegelbalken entfernen.
- Die metallischen Oberflächen mit normalen Reinigungsmitteln für Edelstahl reinigen.
- Das Bedienpanel muss sauber und trocken gehalten werden.

## 8. PROBLEMLÖSUNG





### ACHTUNG!











Die Kapitel in Bezug auf die Sicherheit berücksichtigen.

### 8.1 Was tun wenn....

Problem	Mögliche Ursache	Lösung
Die Versiegelung des Beutels wurde nicht korrekt ausgeführt.	Die Versiegelungsdauer ist nicht korrekt.	Die Versiegelungsdauer einstellen.
	Die Dichtung des Deckels ist schmutzig oder verschlissen.	Die Dichtung des Deckels reinigen oder austauschen (für den Austausch den Technischen Kundendienst kontaktieren).
	Der Beutel wurde nicht korrekt am Siegelbalken positioniert.	Den Beutel korrekt positionieren.
	Der Siegelbalken ist abgenutzt (die Teflonverkleidung ist verbrannt).	Den Siegelbalken austauschen (für den Austausch den Technischen Kundendienst kontaktieren).
	Die Klinge unter dem Teflon des Siegelbalkens ist beschädigt.	Die Klinge austauschen (für den Austausch den Technischen Kundendienst kontaktieren).
Das endgültige Vakuum ist unzureichend.	Die eingestellte Vakuumstufe ist nicht korrekt.	Die Vakuumstufe ändern.
	Die Dichtung des Deckels ist schmutzig oder verschlissen.	Die Dichtung des Deckels reinigen oder austauschen (für den Austausch den Technischen Kundendienst kontaktieren).
	Der Deckel ist nicht korrekt geschlossen.	Den Deckel korrekt verschließen. Sicherstellen, dass sich zwischen dem Deckel und der Wanne keine Gegenstände oder Schmutz befinden.
	Verunreinigungen im Pumpenöl.	Einen „Rekonditionierungszyklus“ durchführen (siehe Abs. 6.6).
Der Deckel öffnet nicht.	Keine Stromversorgung.	Abwarten, bis die Stromversorgung wiederhergestellt ist.
Der Deckel weist Risse oder Bruchstellen auf.	Der Deckel ist beschädigt.	Den Deckel austauschen (für den Austausch den Technischen Kundendienst kontaktieren).

Die Tasten  und  blinken.	„Rekonditionierungszyklus“ im Gang.	Den Abschluss des „Rekonditionierungszyklus“ (15 Minuten) abwarten.
Bei Ausschalten des Geräts läuft die Pumpe an.	Der regelmäßig ausgeführte „Rekonditionierungszyklus“ wurde gestartet (siehe Abs. 6.6).	Den Abschluss des „Rekonditionierungszyklus“ (15 Minuten) abwarten.
Der Vakuumzyklus setzt ein und die Vakuumpumpe läuft an, doch innerhalb weniger Sekunden hält sie bei blinkender Taste wieder an  (ohne die Luft aus der Wanne abgesaugt oder den Behälter versiegelt zu haben).	Der Deckel ist nicht vorschriftsmäßig verschlossen worden.  Die Dichtung des Deckels ist schmutzig oder abgenutzt.	Einen leichten Druck auf den Deckel ausüben, damit die Dichtung hermetisch anhaften kann.  Die Dichtung sauber machen. Die Dichtung ersetzen.

## Alarmmeldungen

Alarm	Mögliche Ursache	Lösung
Die Taste  blinkt ununterbrochen.	Die Steuerkarte ist defekt.	Den Technischen Kundendienst kontaktieren.
Die Taste  blinkt ununterbrochen.	Das Vakuum wurde nicht erreicht.	Die Dichtung des Deckels reinigen oder austauschen (für den Austausch den Technischen Kundendienst kontaktieren). Kontrollieren, ob der Deckel richtig schließt. Die Taste  zur Rückstellung des Alarms drücken.
Die Tasten  und  blinken ununterbrochen.	Das Öl der Pumpe muss ausgewechselt werden.	Den Technischen Kundendienst kontaktieren.
Die Taste  blinkt ununterbrochen.	Der Verpackungszyklus wurde vorzeitig beendet, da ein feuchtes Produkt verpackt wird.	Die Taste  zur Rückstellung des Alarms drücken.
Nur Taste  blinkt ununterbrochen.	Die Maschine ist im Betriebsmodus „Erstinbetriebnahme“ (siehe Anweisungen zum Einbau – Phase 13).	Den Deckel schließen, dabei einen leichten Druck ausüben und die Taste  drücken. Alle Tasten leuchten auf und der Öl-Rekonditionierungszyklus wird gestartet (die Tasten  und  blinken). 15 Minuten warten, bis der Vorgang abgeschlossen ist.

## 8.2 Kundendienstdaten

Sollte es nicht möglich sein, eine Lösung für das Problem zu finden, muss eine autorisierte Technische Kundendienststelle kontaktiert werden.

Die notwendigen Informationen in Bezug auf den Technischen Kundendienst finden sich auf dem Kennschild, das auf der linken Seite des Geräts angebracht ist. Das Kennschild darf niemals entfernt werden.

## 9. UMWELTSCHUTZINFORMATIONEN

Die Materialien mit dem Symbol  müssen wiederverwertet werden. Die Verpackung in den speziellen Recyclingbehälter entsorgen. Helfen Sie, die Umwelt und die menschliche Gesundheit zu schützen und Abfall, der aus elektrischen und elektronischen Geräten stammt, zu recyceln.

Geräte mit dem Symbol  dürfen nicht gemeinsam mit dem normalen Hausmüll entsorgt werden. Das Produkt zur nächstgelegenen Recyclingstelle bringen oder die Wohnsitzgemeinde kontaktieren.

## INDICE

1. INFORMAZIONI PER LA SICUREZZA .....	47
2. ISTRUZIONI PER LA SICUREZZA .....	48
3. DESCRIZIONE DEL PRODOTTO.....	50
4. PANNELLO COMANDI.....	50
5. PREPARAZIONE AL PRIMO UTILIZZO .....	51
6. UTILIZZO QUOTIDIANO .....	51
7. PULIZIA E CURA.....	56
8. RISOLUZIONE DEI PROBLEMI.....	57
9. CONSIDERAZIONI SULL'AMBIENTE.....	59

## PER RISULTATI PERFETTI

Grazie per aver scelto di acquistare questo prodotto AEG. Lo abbiamo creato per fornirvi prestazioni impeccabili per molti anni, grazie a tecnologie innovative che vi semplificheranno la vita - funzioni che non troverete sulle normali apparecchiature. Vi invitiamo a dedicare qualche minuto alla lettura per sapere come trarre il massimo dal vostro elettrodomestico.

**Visitate il nostro sito web per:**



Ricevere consigli, scaricare i nostri opuscoli, eliminare eventuali anomalie, ottenere informazioni sull'assistenza:

**[www.aeg.com](http://www.aeg.com)**



Registrare il vostro prodotto e ricevere un servizio migliore:

**[www.aeg.com/productregistration](http://www.aeg.com/productregistration)**



Acquistare accessori, materiali di consumo e ricambi originali per la vostra apparecchiatura:

**[www.aeg.com/shop](http://www.aeg.com/shop)**

## SERVIZIO CLIENTI E MANUTENZIONE

Consigliamo sempre l'impiego di ricambi originali.

Quando si contatta il Centro di Assistenza autorizzato, accertarsi di disporre dei seguenti dati: Modello, PNC, numero di serie.

Le informazioni si trovano sulla targhetta dei dati.

 Avvertenza/Attenzione - Importanti Informazioni per la sicurezza.

 Informazioni e consigli generali.

 Informazioni sull'ambiente.

Con riserva di modifiche.

# 1. ⚠️ INFORMAZIONI PER LA SICUREZZA

Leggere attentamente le istruzioni fornite prima di installare e utilizzare l'apparecchiatura. Il produttore non è responsabile se un'installazione ed un uso non corretto dell'apparecchiatura provocano lesioni e danni. Tenere sempre le istruzioni a portata di mano come riferimento futuro.

## 1.1 Sicurezza dei bambini e delle persone vulnerabili

- Questa apparecchiatura può essere usata da bambini a partire dagli 8 anni e da adulti con limitate capacità fisiche, sensoriali o mentali o con scarsa esperienza o conoscenza sull'uso dell'apparecchiatura, solamente se sorvegliati o se istruiti relativamente all'uso dell'apparecchiatura e se hanno capito i rischi coinvolti.
- Non consentire ai bambini di giocare con l'apparecchiatura.
- Tenere i materiali di imballaggio al di fuori della portata dei bambini.
- Tenere i bambini e gli animali domestici lontano dall'apparecchiatura durante il funzionamento.
- La pulizia e gli interventi di manutenzione non devono essere eseguiti dai bambini senza supervisione.
- Tenere lontani i bambini al di sotto dei 3 anni se non costantemente supervisionati.

## 1.2 Avvertenze di sicurezza generali

- L'installazione dell'apparecchiatura e la sostituzione dei cavi deve essere svolta unicamente da personale qualificato.
- Prima di eseguire qualsiasi intervento di manutenzione, scollegare l'apparecchiatura dalla rete elettrica.
- Non usare una pulitrice a vapore per pulire l'apparecchiatura.
- Non utilizzare detergenti abrasivi o raschietti di metallo per pulire l'apparecchiatura.

- Se il cavo di alimentazione è danneggiato, deve essere sostituito dal produttore, da un tecnico autorizzato o da una persona qualificata per evitare situazioni di pericolo.

## 2. ISTRUZIONI PER LA SICUREZZA

### 2.1 Installazione



#### **ATTENZIONE!**

L'installazione dell'apparecchiatura deve essere eseguita da personale qualificato.

- Rimuovere tutti i materiali di imballaggio.
- Non installare o utilizzare l'apparecchiatura se danneggiata.
- Attenersi alle istruzioni fornite insieme all'apparecchiatura.
- Prestare sempre attenzione in fase di spostamento dell'apparecchiatura. Indossare sempre guanti di sicurezza.
- Non capovolgere o inclinare l'apparecchiatura! Questo da luogo alla fuoriuscita dell'olio dalla pompa che potrebbe danneggiare l'apparecchiatura stessa.
- È necessario rispettare la distanza minima dalle altre apparecchiature.
- Assicurarsi che l'apparecchiatura sia installata e adeguatamente ancorata a una struttura fissa.
- I lati dell'apparecchiatura devono restare adiacenti ad apparecchiature o unità con la stessa altezza.
- Non utilizzare prese multiple e prolunghe.
- Accertarsi di non danneggiare la spina e il cavo. Qualora il cavo elettrico debba essere sostituito, l'intervento dovrà essere effettuato dal nostro Centro di Assistenza.
- I dispositivi di protezione da scosse elettriche devono essere fissati in modo tale da non poter essere disattivati senza l'uso di attrezzi.
- Inserire la spina di alimentazione nella presa solo al termine dell'installazione.
- Nel caso in cui la spina di corrente sia allentata, non collegarla alla presa.
- Non tirare il cavo di alimentazione per scollegare l'apparecchiatura. Tirare solo la spina.
- Servirsi unicamente di dispositivi di isolamento adeguati: interruttori automatici, fusibili (quelli a tappo devono essere rimossi dal portafusibile), sganciatori per correnti di guasto a terra e relè.
- L'impianto elettrico deve essere dotato di un dispositivo di isolamento che consenta di scollegare l'apparecchiatura dalla presa di corrente a tutti i poli. Il dispositivo di isolamento deve avere una larghezza dell'apertura di contatto non inferiore ai 3 mm.
- Questa apparecchiatura è conforme alle direttive CEE.

### 2.2 Collegamento elettrico



#### **ATTENZIONE!**

Rischio di incendio e scossa elettrica.

- Tutti i collegamenti elettrici devono essere realizzati da un elettricista qualificato.
- L'apparecchiatura deve disporre di una messa a terra.
- Verificare che i dati elettrici riportati sulla targhetta dei dati corrispondano a quelli dell'impianto. In caso contrario, contattare un elettricista.
- Utilizzare sempre una presa elettrica con contatto di protezione correttamente installata.



## 2.3 Utilizzo



### ATTENZIONE!

Rischio di lesioni, ustioni, scosse elettriche o esplosioni.

- Non toccare la barra saldante dopo l'uso. Il calore residuo può causare scottature.
- Utilizzare l'apparecchiatura esclusivamente in un ambiente domestico.
- Non apportare modifiche alle specifiche di questa apparecchiatura.
- Non lasciare mai l'apparecchiatura incustodita durante il funzionamento.
- Spegnere l'apparecchiatura dopo ogni utilizzo.
- Non mettere in funzione l'apparecchiatura con le mani umide o quando c'è un contatto con l'acqua.
- Non esercitare pressione sul cassetto.
- Non utilizzare l'apparecchiatura come superficie di lavoro o come piano di appoggio.
- Evitare la presenza di scintille o fiamme aperte vicino all'apparecchiatura quando si apre il cassetto.
- Non appoggiare o tenere liquidi o materiali infiammabili, né oggetti facilmente incendiabili sull'apparecchiatura, al suo interno o nelle immediate vicinanze.



### ATTENZIONE!

Vi è il rischio di danneggiare l'apparecchiatura.

- Prestare attenzione quando si tolgono o inseriscono gli accessori.

- Non forzare l'apertura del coperchio durante il ciclo di lavoro.
- Non forzare l'apertura del coperchio durante il ciclo di lavoro in mancanza di energia elettrica.
- Non appoggiare nessun peso sul coperchio.
- Evitare di fare cadere qualunque oggetto sul coperchio! Questo potrebbe alterarne l'integrità, causando cricche o rottura.

## 2.4 Pulizia e cura



### ATTENZIONE!

Vi è il rischio di lesioni, incendio o danni all'apparecchiatura.

- Prima di eseguire qualunque intervento di manutenzione, spegnere l'apparecchiatura ed estrarre la spina dalla presa.
- Controllare che l'apparecchiatura sia fredda.

## 2.5 Smaltimento



### ATTENZIONE!

Rischio di lesioni o soffocamento.

- Staccare la spina dall'alimentazione elettrica.
- Tagliare il cavo di rete e smaltirlo.

## 2.6 Assistenza Tecnica

- Per riparare l'apparecchiatura contattare il Centro di Assistenza autorizzato.
- Utilizzare esclusivamente ricambi originali.

### 3. DESCRIZIONE DEL PRODOTTO

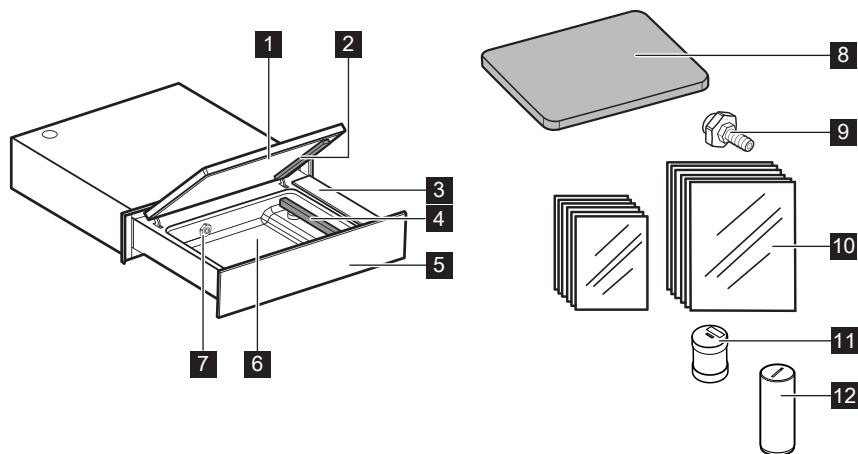

- 1** Coperchio
- 2** Cuscino sigillante
- 3** Pannello comandi
- 4** Barra saldante
- 5** Pannello frontale
- 6** Vasca
- 7** Ugello di aspirazione

- 8** Tavoletta di riempimento
- 9** Raccordo per sottovuoto esterno
- 10** Buste per surgelazione, cottura e conservazione  
N. 25 20x30 cm  
N. 25 25x35 cm
- 11** Filtro per olio
- 12** Tappo

### 4. PANNELLO COMANDI

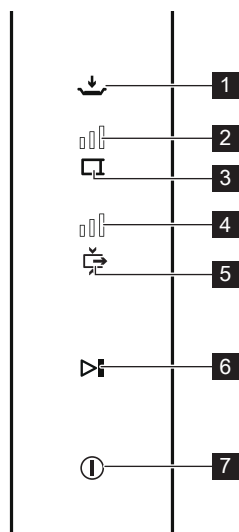

- 1** Pulsante MARINATURA/INFUSIONE
- 2** Indicatore tempo di SALDATURA
- 3** Pulsante tempo di SALDATURA
- 4** Indicatore livello di SOTTOVUOTO
- 5** Pulsante livello di SOTTOVUOTO
- 6** Pulsante AVVIO/ARRESTO
- 7** Pulsante ACCENSIONE/ SPEGNIMENTO

## 5. PREPARAZIONE AL PRIMO UTILIZZO



### ATTENZIONE!

Fare riferimento ai capitoli sulla sicurezza.



### ATTENZIONE!

Inserire l'olio nella macchina prima dell'installazione.



### ATTENZIONE!

Attenersi alle istruzioni fornite insieme all'apparecchiatura.



### ATTENZIONE!

Il tappo in plastica **12** estratto in fase di installazione, va conservato per futuri interventi di assistenza.

### 5.1 Prima pulizia

- Fare riferimento al capitolo "PULIZIA E CURA".
- Pulire con un panno umido tutte le parti prima del primo utilizzo.

### 5.2 Primo utilizzo

Accendere l'apparecchiatura premendo per almeno 1 secondo il pulsante .















Se lampeggia solo il pulsante  eseguire la procedura di sblocco (vedi le istruzioni di installazione - fase 13).

Altrimenti eseguire un ciclo di ricondizionamento olio come indicato al par. 6.6.





## 6. UTILIZZO QUOTIDIANO

Questo prodotto è ideale per:

- Confezionamento alimenti sottovuoto per cottura a bassa temperatura "SousVide".
- Confezionamento alimenti sottovuoto per conservazione.
- Marinatura/infusione alimenti.



Pulsante	Descrizione	Funzione
	Pulsante ACCENSIONE/ SPEGNIMENTO	Per accendere/spengere l'apparecchiatura.
	Pulsante AVVIO/ ARRESTO	Per avviare/arrestare il ciclo di confezionamento.
	Pulsante SOTTOVUOTO	Per impostare uno dei 4 livelli di sottovuoto disponibili. Il valore preimpostato è MAX.
		 solo saldatura
		 MIN.
		 MED.
		 MAX.
	Pulsante SALDATURA	Per impostare il tempo di saldatura in base allo spessore della busta <sup>1)</sup> . L'apparecchiatura è preimpostata su 2,5 s, tempo ideale per le buste in dotazione.
		 disabilitata
		 1,5 s
		 2,5 s
		 4,0 s
	Pulsante MARINATURA/ INFUSIONE	Per attivare la funzione di marinatura/infusione.

<sup>1)</sup> Maggiore è lo spessore della busta, più alto sarà il tempo da impostare.





- Estrarre il cassetto fino alla massima apertura.
  - Accendere l'apparecchiatura premendo per almeno 1 secondo il pulsante .
  - Modificare se necessario il livello di sottovuoto e il tempo di saldatura.
  - Sollevare il coperchio e posizionare nella vasca la busta con all'interno l'alimento da confezionare lasciando almeno 2 cm oltre la barra saldante.
  - Per garantire una perfetta saldatura è importante non sporcare la busta nella zona in cui avviene la saldatura. Per questo si consiglia di ripiegare il lato interno della busta verso l'esterno per 4/5 cm. Una volta inserito l'alimento ripiegare la busta nella condizione iniziale.
  - Per prodotti poco voluminosi utilizzare la tavoletta di riempimento in dotazione in quanto favorisce una migliore posizione della busta rispetto alla barra saldante.
  - Chiudere il coperchio esercitando una leggera pressione e premere il pulsante  il quale inizia a lampeggiare. Il ciclo di confezionamento avrà così inizio.
  - Al termine del ciclo tale pulsante smetterà di lampeggiare.
  - Aprire il coperchio ed estrarre la busta.
-  Non toccare la barra saldante dopo l'uso. Il calore residuo può causare scottature.
- Spegner l'apparecchiatura tenendo premuto il pulsante .
-  Se l'apparecchiatura rimane inutilizzata per 60 minuti si spegne automaticamente.

### Alimenti liquidi

Se durante il funzionamento si preme il pulsante ►||, il ciclo si arresta e viene eseguita immediatamente la saldatura della busta. Questa procedura è da utilizzare se si confezionano prodotti liquidi che durante il ciclo di sottovuoto possono andare in ebollizione.

 Nota: Periodicamente l'apparecchiatura esegue in modo automatico un ciclo di ricondizionamento (vedi par. 6.6) durante il quale lampeggiano i pulsanti ►|| e . Lasciare eseguire il ciclo senza intervenire sull'apparecchiatura fino a quando i 2 pulsanti smetteranno di lampeggiare.

A seconda dell'alimento da confezionare si consiglia di impostare il livello di sottovuoto come indicato in tabella:

Livello di sottovuoto 	Utilizzo
	Confezionare, dividere in porzioni senza la creazione di sottovuoto. <b>1)</b>
	Confezionare, dividere in porzioni alimenti particolarmente delicati (insalata, pomodori, etc..) con livello minimo di sottovuoto (MIN).
	<ul style="list-style-type: none"> <li>- Confezionare, dividere in porzioni alimenti delicati (verdure cotte, frutta, carni tenere, pasta) e alimenti liquidi (zuppe, creme, salse).</li> <li>- Marinare in busta.</li> <li>- Cuocere Sottovuoto (SousVide) alimenti delicati (es. pesce) con livello medio di sottovuoto (MED).</li> </ul>
	<ul style="list-style-type: none"> <li>- Confezionare, dividere in porzioni alimenti solidi (verdure crude, formaggi a pasta dura, affettati).</li> <li>- Cuocere Sottovuoto (SousVide) alimenti solidi (es. carni, patate, carote, etc.) con livello massimo di sottovuoto (MAX).</li> <li>- Chiusura ermetica di vasetti in vetro (vedi par. 6.5).</li> </ul>

**1)** Con questa funzione si genera comunque una minima depressione all'interno della busta.

## 6.1 Utilizzo buste

Le buste fornite sono ideali per la surgelazione, conservazione e la cottura di alimenti sottovuoto a basse temperature.

### Cod. per ordine buste: 902979704

50 buste per surgelazione, cottura sottovuoto e conservazione (25 pezzi dimensione: 20x30 cm + 25 pezzi dimensione 25x35 cm)

### Cod. per ordine buste: 9029794014

50 buste per cottura sottovuoto e conservazione (25 pezzi dimensione: 20x30 cm + 25 pezzi dimensione 25x35 cm)



Si raccomanda l'utilizzo di buste originali.

[www.aeg.com/shop](http://www.aeg.com/shop)

## 6.2 Confezionamento alimenti sottovuoto per cottura a bassa temperatura "SousVide"

Questa tecnica prevede che gli alimenti sigillati nella busta sottovuoto siano poi cotti lentamente a basse temperature.

### I vantaggi sono innumerevoli:

- il sapore e la consistenza del cibo rimangono inalterati.
- i sapori e i profumi vengono preservati in quanto gli aromi non vengono persi durante la cottura.
- la minore perdita di liquidi rende i cibi più morbidi e meno asciutti.
- le proprietà nutritive come Sali minerali e vitamine vengono preservati nell'alimento.
- non è necessario aggiungere né oli né grassi per la cottura.

## 6.3 Confezionamento alimenti sottovuoto per conservazione

Il confezionamento sottovuoto allunga i tempi di conservazione degli alimenti. Nel caso si vuole confezionare sottovuoto alimenti appena cotti, questi vanno prima refrigerati, possibilmente mediante un abbattitore di temperatura.

## 6.4 Marinatura/Infusione

- Inserire in una teglia/piatto l'alimento con la marinata di aromi.
- Accendere l'apparecchiatura premendo per almeno 1 secondo il pulsante .
- Sollevare il coperchio e posizionare la teglia nella vasca.
- Premere il pulsante , il quale inizierà a lampeggiare.
- Chiudere il coperchio esercitando una leggera pressione.
- Premere il pulsante per iniziare il ciclo di marinatura. Tale pulsante inizierà a lampeggiare.
- Al termine del ciclo di marinatura tale pulsante smetterà di lampeggiare.
- Sarà ora possibile aprire il coperchio e togliere la teglia.

Il ciclo di marinatura e infusione ha un tempo preimpostato di 8 minuti. Per aumentare l'infusione, ripetere il ciclo.

Tale infusione è disattivabile in ogni momento premendo il pulsante .



È possibile eseguire la marinatura degli alimenti anche direttamente in busta.

In questo caso impostare il livello di sottovuoto in base alle proprie esigenze.

## 6.5 Funzioni aggiuntive

### “Chiusura ermetica di vasetti in vetro”

È la funzione da utilizzare per chiudere ermeticamente dei vasetti in vetro da utilizzare per vaso-cotture oppure per aumentare il tempo di conservazione del prodotto contenuto (vasi non in dotazione con questa apparecchiatura).

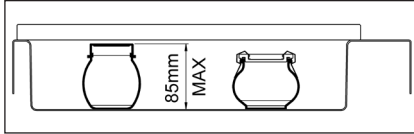

- Impostare il livello di sottovuoto massimo e disabilitare la saldatura .
- Chiudere il vasetto con una leggera pressione e inserirlo nella vasca, chiudere il coperchio esercitando una leggera pressione e premere il pulsante il quale inizia a lampeggiare. Il ciclo di confezionamento avrà così inizio.
- Al termine del ciclo tale pulsante smetterà di lampeggiare.

### “Sottovuoto esterno”

È la funzione da utilizzare per l'eliminazione dell'aria all'interno di speciali contenitori richiudibili ermeticamente (non in dotazione con questa apparecchiatura).

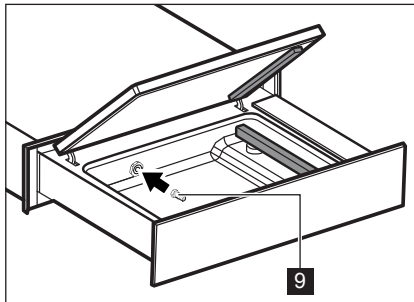

- Per il sottovuoto esterno avvitare il raccordo **9** in dotazione, all'interno della vasca.

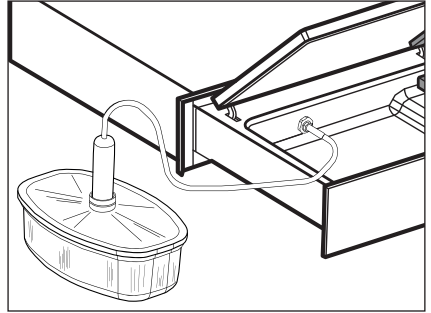

- Collegare il tubo del contenitore al raccordo **9**.
- Impostare il livello di sottovuoto massimo e disabilitare la saldatura .
- Con il coperchio dell'apparecchiatura aperto premere il pulsante per avviare il ciclo di confezionamento. Tale pulsante inizierà a lampeggiare.
- Al termine del ciclo tale pulsante smetterà di lampeggiare.

## 6.6 Ciclo di ricondizionamento

È la funzione da utilizzare nelle seguenti situazioni:

- Prima di utilizzare l'apparecchiatura per la prima volta.
- Dopo che questa è rimasta ferma per un periodo prolungato.
- Dopo aver confezionato prodotti con un'alta percentuale di umidità (es. minestre e zuppe).
- Quando si nota un calo di prestazioni dell'apparecchiatura (es.: aumenta il tempo per raggiungere il sottovuoto o non lo raggiunge).





Questo programma della durata di 15 minuti garantisce una pulizia completa della pompa eliminando qualsiasi emulsione di liquidi che si possono formare nell'olio.

Durante l'esecuzione di questo programma non si deve confezionare nessun prodotto.

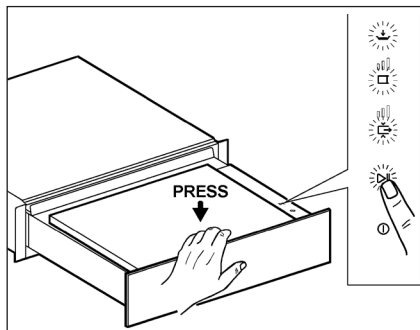
Procedere come indicato di seguito:

- Tenere premuto il pulsante  fino a quando tutti i pulsanti lampeggiano.



- Chiudere il coperchio esercitando una leggera pressione.
- Premere il pulsante . Durante l'esecuzione del programma lampeggiano i pulsanti  e .
- Al termine del ciclo (15 minuti) il pulsante  smetterà di lampeggiare e l'apparecchiatura sarà pronta all'utilizzo.

## 7. PULIZIA E CURA



### ATTENZIONE!

Fare riferimento ai capitoli sulla sicurezza.

- Pulire l'apparecchiatura dopo ogni utilizzo con un panno inumidito e morbido.

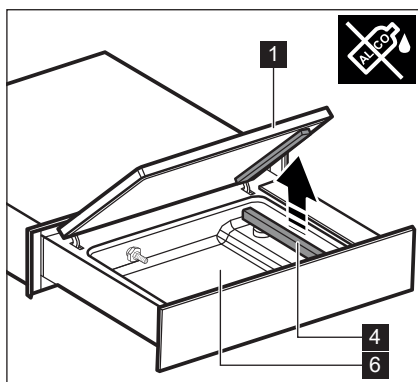

- Per la pulizia del coperchio in plexiglas **1** pulire sia l'esterno che l'interno esclusivamente con detersivi neutri (acqua e sapone).
- Non usare prodotti abrasivi, detersivi a base di alcool, spugnette abrasive, solventi od oggetti metallici.
- Nel caso in cui si usino prodotti per la pulizia della vasca in acciaio **6**, attenersi alle istruzioni di sicurezza indicate sulla confezione.
- Per la pulizia della vasca **6**, soprattutto in caso di residui liquidi, si consiglia di estrarre verso l'alto la barra saldante **4**.
- Pulire la barra saldante **4** con un panno asciutto. Rimuovere eventuali residui che si depositano sulla barra.
- Pulire le superfici metalliche con normali detersivi per l'acciaio inox.
- Mantenere pulito e asciutto il pannello comandi.



## 8. RISOLUZIONE DEI PROBLEMI



### ATTENZIONE!











Fare riferimento ai capitoli sulla sicurezza.

### 8.1 Cosa fare se...

Problema	Possibile causa	Soluzione
La saldatura della busta non è eseguita correttamente.	Il tempo di saldatura non è corretto.	Modificare il tempo di saldatura.
	La guarnizione del coperchio è sporca o usurata.	Pulire o sostituire la guarnizione del coperchio (per la sostituzione contattare l'Assistenza Tecnica).
	La busta non è posizionata correttamente sulla barra saldante.	Posizionare correttamente la busta.
	La barra saldante è usurata (il rivestimento in teflon è bruciato).	Sostituire la barra saldante (per la sostituzione contattare l'Assistenza Tecnica).
	La lama posizionata sotto il teflon della barra saldante è rotta.	Sostituire la lama (per la sostituzione contattare l'Assistenza Tecnica).
Sottovuoto finale insufficiente.	Il livello di sottovuoto impostato non è corretto.	Modificare il livello di sottovuoto.
	La guarnizione del coperchio è sporca o usurata.	Pulire o sostituire la guarnizione del coperchio (per la sostituzione contattare l'Assistenza Tecnica).
	Il coperchio non è chiuso correttamente.	Chiudere correttamente il coperchio. Verificare che tra coperchio e vasca non ci siano oggetti o sporcizia.
	Impurità presenti nell'olio della pompa.	Eseguire un "ciclo di ricondizionamento" olio (vedi par. 6.6).
Il coperchio non si apre.	Mancanza dell'energia elettrica.	Attendere il ripristino dell'energia elettrica.
Il coperchio presenta cricche o rotture.	Coperchio danneggiato.	Sostituire il coperchio (per la sostituzione contattare l'Assistenza Tecnica).
Lampeggiano i pulsanti  e  .	"Ciclo di ricondizionamento" in corso.	Attendere la fine del "ciclo di ricondizionamento" (15 minuti).

Spegnendo la macchina la pompa si avvia.	È stato avviato il “ciclo di ricondizionamento” olio periodico (vedi par. 6.6).	Attendere la fine del “ciclo di ricondizionamento” (15 minuti).
Il ciclo di sottovuoto inizia, attivando la pompa del vuoto, ma si arresta entro pochi secondi e lampeggia il pulsante  (senza aver rimosso l'aria dalla vasca o aver saldato la busta).	Il coperchio non è stato chiuso correttamente.	Applicare una leggera pressione sul coperchio per permettere la tenuta ermetica della guarnizione.
	La guarnizione del coperchio è sporca o usurata.	Pulire la guarnizione. Sostituire la guarnizione.

### Messaggi di allarme

Allarme	Possibile causa	Soluzione
Il pulsante  lampeggia ininterrottamente.	La scheda elettrica è guasta.	Contattare l'Assistenza Tecnica.
Il pulsante  lampeggia ininterrottamente.	Sottovuoto non raggiunto.	Pulire o sostituire la guarnizione del coperchio. (per la sostituzione contattare l'Assistenza Tecnica). Controllare che il coperchio si chiuda correttamente. Premere il pulsante  per resettare l'allarme.
I pulsanti  e  lampeggiano ininterrottamente.	L'olio della pompa è da sostituire.	Contattare l'Assistenza Tecnica.
Il pulsante  lampeggia ininterrottamente.	Il ciclo di confezionamento è terminato anticipatamente perché si sta confezionando un prodotto umido.	Premere il pulsante  per resettare l'allarme.
Solo il pulsante  lampeggia ininterrottamente.	La macchina è in modalità “primo avvio” (vedi le istruzioni di installazione – fase 13).	Chiudere il coperchio esercitando una leggera pressione e premere il pulsante  . Tutti i pulsanti si accendono e si avvia il ciclo di ricondizionamento olio (i pulsanti  ,  lampeggiano). Attendere 15' per il completamento della procedura.

## 8.2 Dati Assistenza

Qualora non sia possibile trovare una soluzione al problema, contattare il Centro di Assistenza Tecnica autorizzato.

Le informazioni necessarie per il Centro di Assistenza Tecnica si trovano sulla targhetta dei dati posta sul lato sinistro dell'apparecchiatura. Non rimuovere la targhetta dei dati.

## 9. CONSIDERAZIONI SULL'AMBIENTE

Riciclare i materiali con il simbolo .  
Buttare l'imballaggio negli appositi contenitori per il riciclaggio. Aiutare a proteggere l'ambiente e la salute umana e a riciclare rifiuti derivanti da apparecchiature elettriche ed elettroniche.

Non smaltire le apparecchiature che riportano il simbolo  insieme ai normali rifiuti domestici.  
Portare il prodotto al punto di riciclaggio più vicino o contattare il comune di residenza.

[www.aeg.com/shop](http://www.aeg.com/shop)



FM11242A\_01/2019

EAC CE

**AEG**