

Optimo 19L

FR

NL

DE

EN

ES

IT

PT

RU

KK

UK



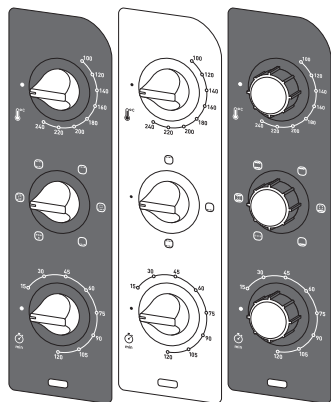
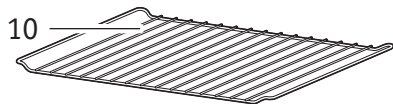
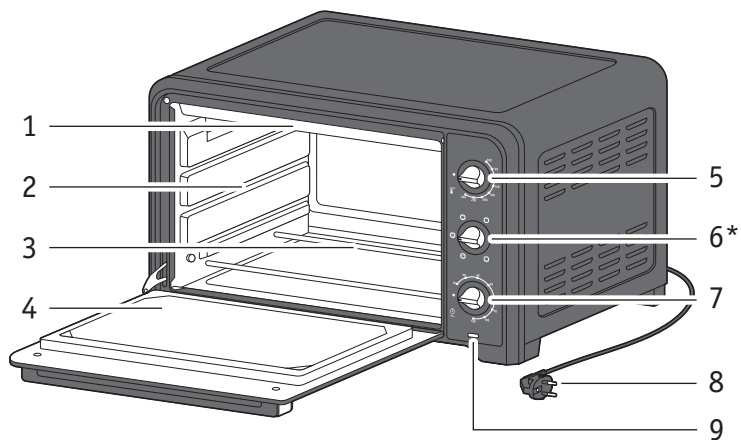

* selon modèle - afhankelijk van het model - je nach Modell - depending on the model - según el modelo - in base al modelo -
 consoante o modelo - В зависимости от модели - үлгіге байланысты - залежи від моделі

DESCRIPTION

- 1 Résistance supérieure
- 2 Parois en acier à revêtement aluminium
- 3 Résistance inférieure
- 4 Porte double parois
- 5 Bouton de réglage température
- 6 Bouton des fonctions*
- 7 Bouton de minuterie
- 8 Cordon d'alimentation
- 9 Voyant de fonctionnement
- 10 Grille réversible
- 11 Plat lèche-frite*

BESCHRIJVING

- 1 Bovenste verwarmingselement
- 2 Stalen wanden met aluminiumcoating
- 3 Onderste verwarmingselement
- 4 Dubbelwandige deur
- 5 Regelbare thermostaatknop
- 6 Functieknop*
- 7 Timerknop
- 8 Snoer
- 9 Aan/uit-controlelampje
- 10 Omkeerbaar grillrooster
- 11 Ovenschaal*

BESCHREIBUNG

- 1 Oberes Heizelement
- 2 Aluminiumbeschichtete Stahlwände
- 3 Unteres Heizelement
- 4 Doppelwandige Tür
- 5 Temperaturregler
- 6 Funktionsknopf*
- 7 Timer-Knopf
- 8 Netzkabel
- 9 Betriebskontrollleuchte
- 10 Umkehrbarer Grillrost
- 11 Backblech*

DESCRIPTION

- 1 Top heating element
- 2 Aluminium coated steel walls
- 3 Bottom heating element
- 4 Double-wall door
- 5 Temperature control button
- 6 Functions button*
- 7 Timer button
- 8 Power cord
- 9 Power indicator light
- 10 Reversible grill rack
- 11 Food tray*

DESCRIPCIÓN

- 1 Resistencia superior
- 2 Paredes de acero inoxidable con recubrimiento de aluminio
- 3 Resistencia inferior
- 4 Puerta de doble cristal
- 5 Botón de ajuste de temperatura
- 6 Botón de funciones*
- 7 Botón de temporizador
- 8 Cable de alimentación
- 9 Indicador de funcionamiento
- 10 Parrilla de grill reversible
- 11 Bandeja de comida*

* selon modèle - afhankelijk van het model - je nach Modell - depending on the model - según el modelo - in base al modelo - consoante o modelo - В зависимости от модели - үлгіге байланысты - залежно від моделі

DESCRIZIONE

- 1 Elemento riscaldante superiore
- 2 Pareti in acciaio con rivestimento in alluminio
- 3 Elemento riscaldante inferiore
- 4 Porta a doppia parete
- 5 Pulsante di regolazione della temperatura
- 6 Pulsante funzioni*
- 7 Pulsante timer
- 8 Cavo di alimentazione
- 9 Spia di alimentazione
- 10 Griglia di cottura reversibile
- 11 Vassoio degli alimenti*

DESCRIÇÃO

- 1 Resistência superior
- 2 Paredes de aço revestidas a alumínio
- 3 Resistência inferior
- 4 Porta de parede dupla
- 5 Botão de regulação da temperatura
- 6 Botão das funções*
- 7 Botão temporizador
- 8 Cabo de alimentação
- 9 Luz piloto de funcionamento
- 10 Grelha reversível
- 11 Tabuleiro*

ОПИСАНИЕ

- 1 Верхний нагревательный элемент
- 2 Стальные стенки с алюминиевым покрытием
- 3 Нижний нагревательный элемент
- 4 Двухслойная дверца
- 5 Кнопка контроля температуры
- 6 Кнопка выбора функций*
- 7 Кнопка таймера
- 8 Кабель питания
- 9 Индикатор питания
- 10 Двухсторонняя решетка для гриля
- 11 Противень*

СИПАТТАМА

- 1 Жоғарғы қыздыру элементі
- 2 Алюминиймен қапталған болат қабырғалар
- 3 Төменгі қыздыру элементі
- 4 Қос қабырғалы есік
- 5 Температураны басқару түймесі
- 6 Функциялар түймесі*
- 7 Таймер түймесі
- 8 Қуат сымы
- 9 Қуат индикаторының шамы
- 10 Аударуға болатын гриль сөресі
- 11 Тамақ науасы*

ОПИС

- 1 Верхній нагрівальний елемент
- 2 Сталеві стінки з алюмінієвим покриттям
- 3 Нижній нагрівальний елемент
- 4 Дверцята з подвійними стінками
- 5 Кнопка регулювання температури
- 6 Кнопка вибору функцій*
- 7 Кнопка таймера
- 8 Шнур живлення
- 9 Світловий індикатор живлення
- 10 Двостороння решітка для гриля
- 11 Піднос*

* selon modèle - afhankelijk van het model - je nach Modell - depending on the model - según el modelo - in base al modello - consoante o modelo - В зависимости от модели - үлгіге байланысты - залежно від моделі

1

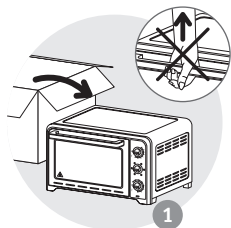

1

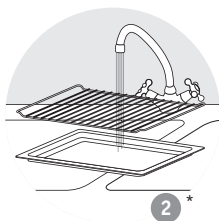

2*

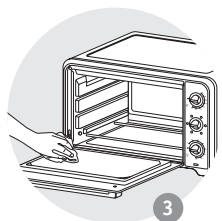

3

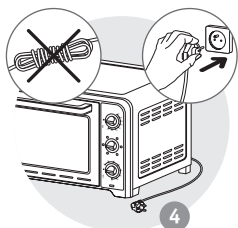

4

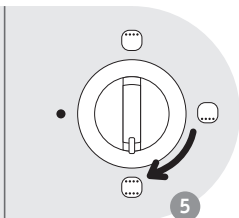
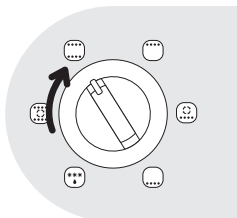

5

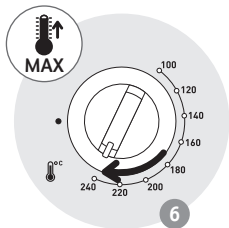

6

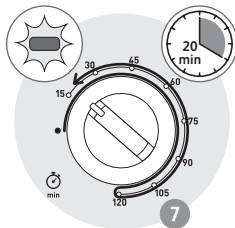

7

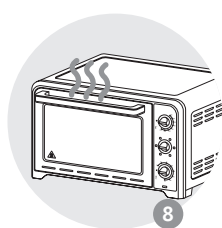

8

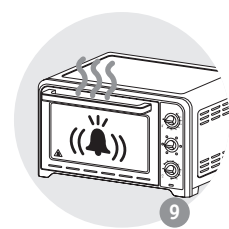

9

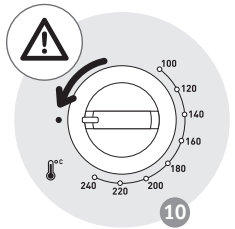

10

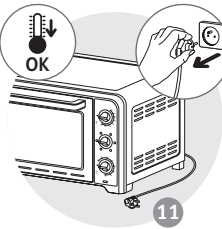

11

* selon modèle - afhankelijk van het model - je nach Modell - depending on the model - según el modelo - in base al modelo - consoante o modelo - В зависимости от модели - үлгіге байланысты - залежно від моделі

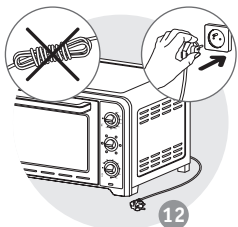

12

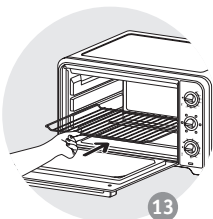

13

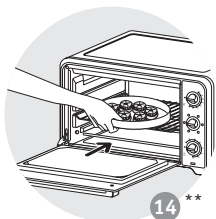

14 **

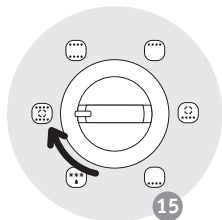

15

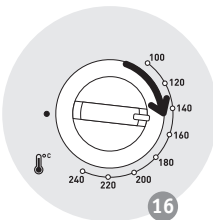

16

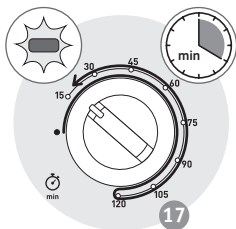

17

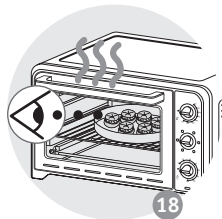

18

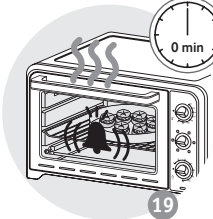

19

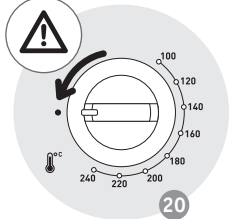

20

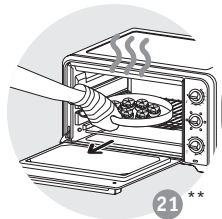

21 **

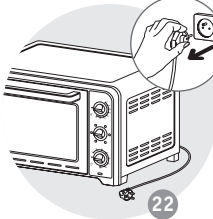

22

* selon modèle
afhankelijk van het model
je nach Modell
depending on the model
según el modelo
in base al modelo
consoante o modelo
В зависимости от модели
үлгіге байланысты
залежно від моделі

** Plat non fourni avec l'appareil - Schaal niet bij het apparaat inbegrepen - Platte nicht im Lieferumfang inbegriffen - The dish is not supplied with the appliance - El plato no es suministrado con el aparato - Piatto non fornito con l'apparecchio - Travessa não fornecida com o aparelho - Блюдо не входит в комплект - Құрылғымен бірге тәрелке қамтамасыз етілмейді - Блюдо не входит в комплект поставки прибора

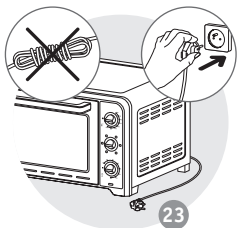

23

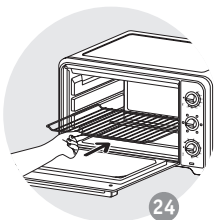

24

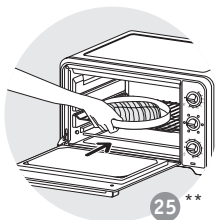

25 **

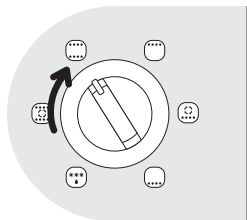

26

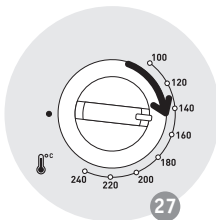

27

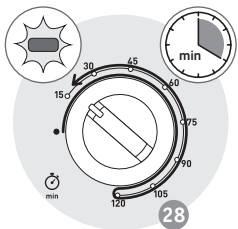

28

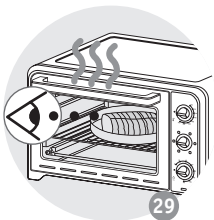

29

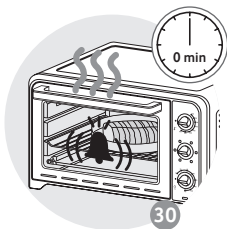

30

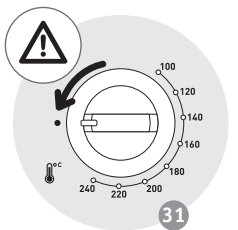

31

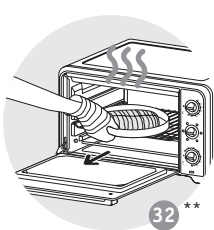

32 **

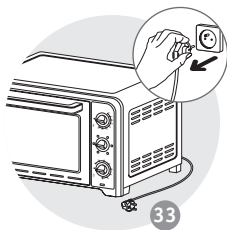

33

** Plat non fourni avec l'appareil - Schaal niet bij het apparaat inbegrepen - Platte nicht in Lieferumfang inbegriffen - The dish is not supplied with the appliance - El plato no es suministrado con el aparato - Piatto non fornito con l'apparecchio - Travessa não fornecida com o aparelho - Блюдо не входит в комплект - Құрылғымен бірге тәрелке қамтамасыз етілмейді - Блюдо не входит в комплект поставки прибора

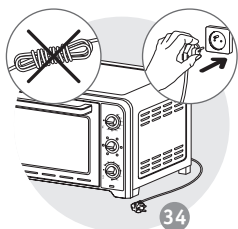

34

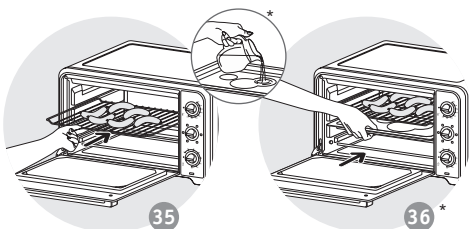

35

36*

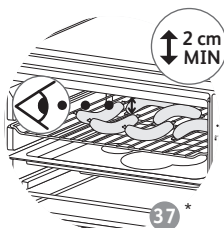

37*

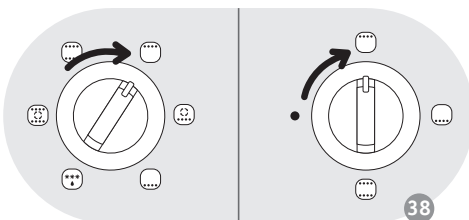

38

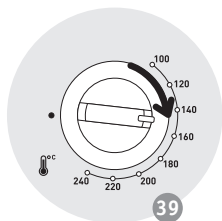

39

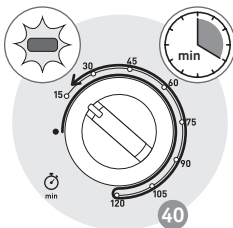

40

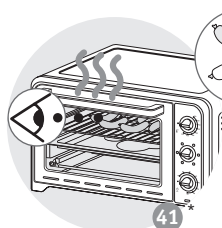

41*

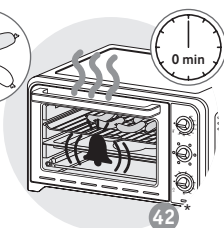

42*

* selon modèle - afhankelijk van het model - je nach Modell - depending on the model - según el modelo - in base al modelo -
consoante o modelo - В зависимости от модели - үлгіге байланысты - залежно від моделі

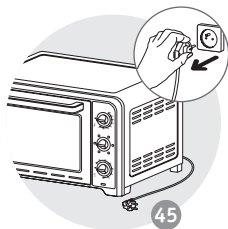
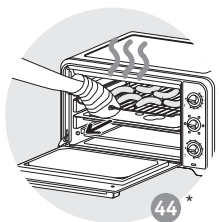
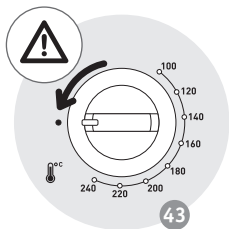

* selon modèle - afhankelijk van het model - je nach Modell - depending on the model - según el modelo - in base al modelo -
consoante o modelo - В зависимости от модели - улігіе байланысты - залежно від моделі

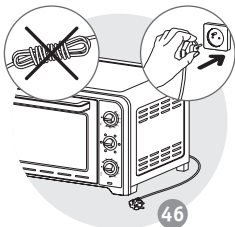

46

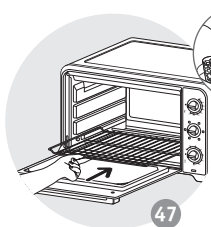

47

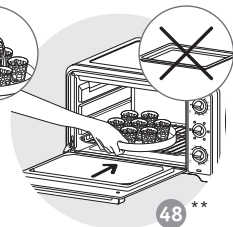

48 **

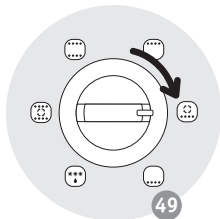

49

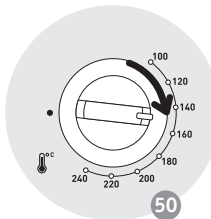

50

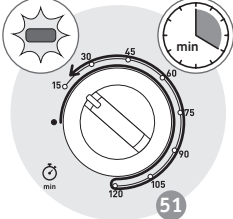

51

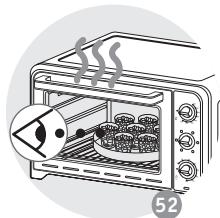

52

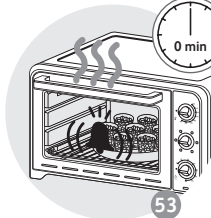

53

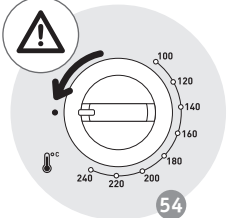

54

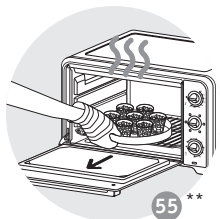

55 **

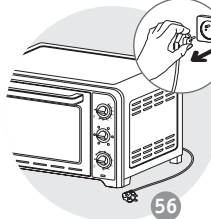

56

* selon modèle
afhankelijk van het model
je nach Modell
depending on the model
según el modelo
in base al modelo
consoante o modelo
В зависимости от модели
үлгіге байланысты
залежно від моделі

** Plat non fourni avec l'appareil - Schaal niet bij het apparaat inbegrepen - Platte nicht im Lieferumfang inbegriffen - The dish is not supplied with the appliance - El plato no es suministrado con el aparato - Piatto non fornito con l'apparecchio - Travessa não fornecida com o aparelho - Блюдо не входит в комплект - Құрылғымен бірге төрелке қамтамасыз етілмейді - Блюдо не входит в комплект поставки прилада

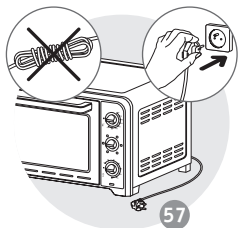

57

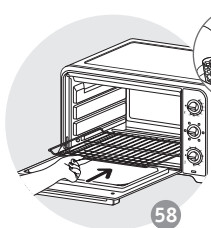

58

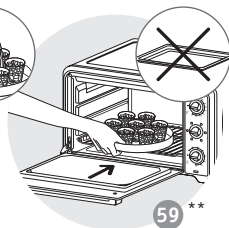

59 **

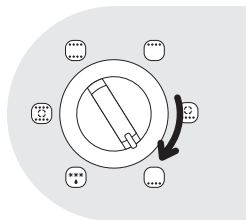

60

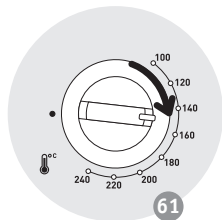

61

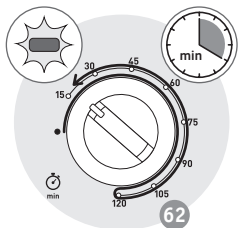

62

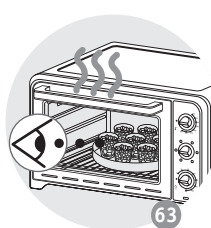

63

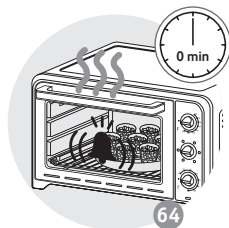

64

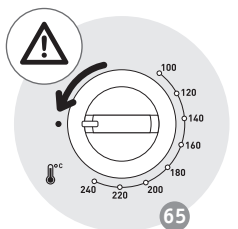

65

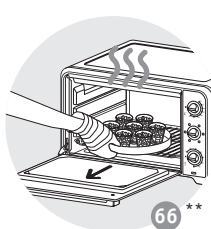

66 **

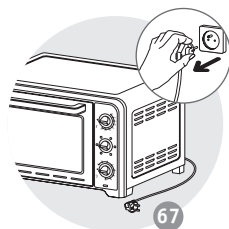

67

** Plat non fourni avec l'appareil - Schaal niet bij het apparaat inbegrepen - Platte nicht in Lieferumfang inbegriffen - The dish is not supplied with the appliance - El plato no es suministrado con el aparato - Piatto non fornito con l'apparecchio - Travessa não fornecida com o aparelho - Блюдо не входит в комплект - Құрылғымен бірге тәрелке қамтамасыз етілмейді - Блюдо не входит в комплект поставки прибора

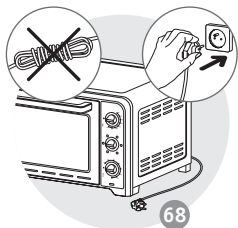

68

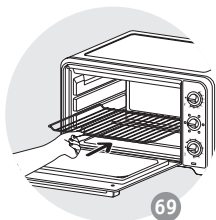

69

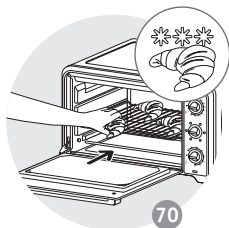

70

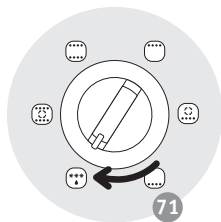

71

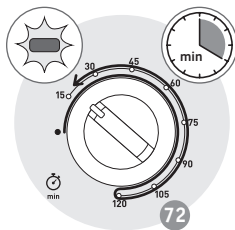

72

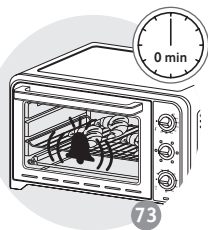

73

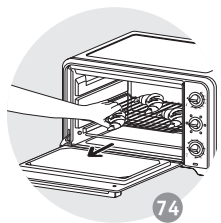

74

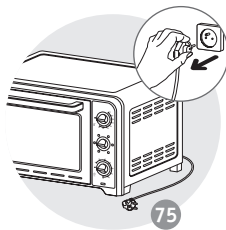

75

* selon modèle - afhankelijk van het model - je nach Modell - depending on the model - según el modelo - in base al modello -
consoante o modelo - В зависимости от модели - үлгіге байланысты - залежно від моделі

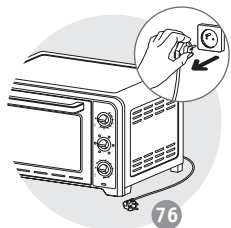

76

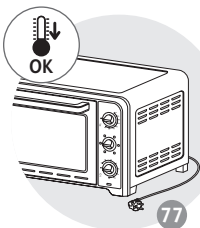

77

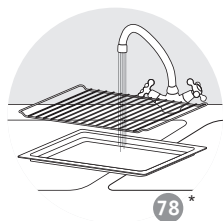

78*

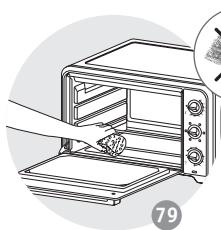

79

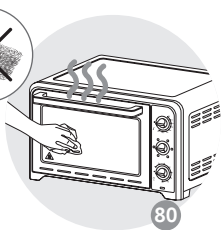

80

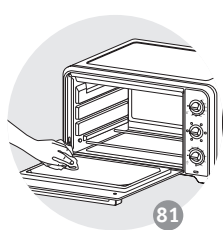

81

* selon modèle - afhankelijk van het model - je nach Modell - depending on the model - según el modelo - in base al modelo -
consoante o modelo - В зависимости от модели - үлгіге байланысты - залежно від моделі



						min
	x4			10mins	240	20
	870g			10mins	230	65
	750g			10mins	240	42
	500g			-	240	50
	1000g			-	240	80
	x4			-	240	22
	x8			-	240	15
	350g			10mins	210	12
	350g			10mins	210	11
				10mins	240	40
	350g			10mins	240	16
				-	240	31
				10mins	200	40







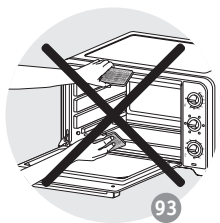
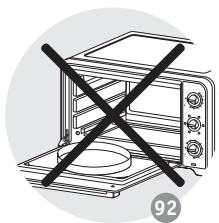
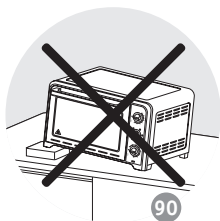
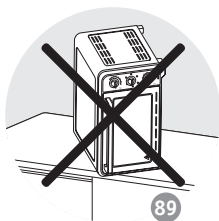
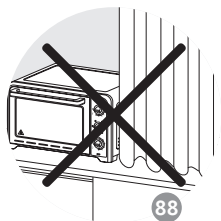
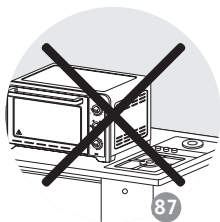
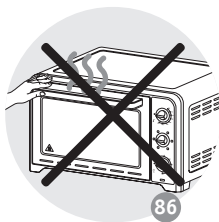
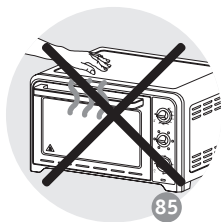
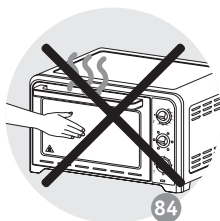
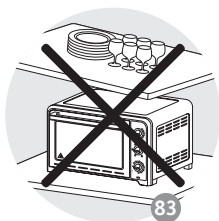
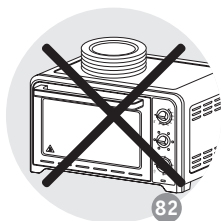

* selon modèle - afhankelijk van het model - je nach Modell - depending on the model - según el modelo - in base al modello -
consoante o modelo - В зависимости от модели - улігіе байлаысты - залежно від модели

				10mins	200	18
				10mins	200	40
	x6			10mins	200	10
	x6			10mins	200	16
				10mins	240	55
				10mins	240	25

* selon modèle - afhankelijk van het model - je nach Modell - depending on the model - según el modelo - in base al modello -
 consoante o modelo - В зависимости от модели - үлгіге байланысты - залежно від моделі



INTERNATIONAL GUARANTEE: COUNTRY LIST

							
ARGENTINA	0800-122-2732	مصر EGYPT	16622	SLOVENIJA SLOVENIA	02 234 94 90	MALAYSIA	603 7802 3000
ՀԱՅԱՍՏԱՆ ARMENIA	010 55-76-707	EESTI ESTONIA	668 1286	ΕΛΛΑΔΑ GREECE	2106371251	MEXICO	(01800) 112 8325
AUSTRALIA	1300307824	SUOMI FINLAND	09 622 94 20	香港 HONG KONG	8130 8998	MOLDOVA	22 929249
ÖSTERREICH AUSTRIA	01 890 3476	France Continentale + Guadeloupe, Martinique, Réunion, Saint-Martin	09 74 50 47 74	MAGYARORSZÁG HUNGARY	06 1 801 8434	NEDERLAND The Netherlands	0318 58 24 24
البحرين BAHRAIN	17716666	DEUTSCHLAND GERMANY	0212 387 400	INDONESIA	+62 21 5793 7007	NEW ZEALAND	0800 700 711
БЕЛАРУСЬ BELARUS	017 2239290	عمان سلطنة OMAN	24703471	ITALIA ITALY	1 99 207 354	NORGE NORWAY	815 09 567
BELGIQUE BELGIE BELGIUM	070 23 31 59	POLSKA POLAND	801 300 420 koszt jak za pocztaecze lokalne	日本 JAPAN	0570-077772	SOUTH AFRICA	0100201730
BOSNA I HERCEGOVINA	Info-linija za potrosaae 033 551 220	PORTUGAL	808 284 735	الاردن JORDAN	5665505	ESPAÑA SPAIN	902 31 24 00
BRASIL BRAZIL	11 2915-4400	قطر QATAR	44485555	ҚАЗАҚСТАН KAZAKHSTAN	727 378 39 39	SVERIGE SWEDEN	08 594 213 30
БЪЛГАРИЯ BULGARIA	0700 10 330	REPUBLIC OF IRELAND	01 677 4003	한국어 KOREA I	1588-1588	SUISSE SCHWEIZ SWITZERLAND	044 837 18 40
CANADA	1-800-418-3325	ROMANIA	0 21 316 87 84	الكويت KUWAIT	24831000	ประเทศไทย THAILAND	02 769 7477
CHILE	02 2 894 46 06	РОССИЯ RUSSIA	495 213 32 30	LATVIJA LATVIA	6 616 3403	TÜRKIYE TURKEY	444 40 50
COLOMBIA	018000520022	السعودية العربية المملكة SAUDI ARABIA	920023701	لبنان LEBANON	4414727	المملكة العربية الامارات UAE	8002272
HRVATSKA CROATIA	01 30 15 294	SRBIJA SERBIA	060 0 732 000	LIETUVA LITHUANIA	5 214 0057	Україна UKRAINE	044 300 13 04
ČESKÁ REPUBLIKA CZECH REPUBLIC	731 010 111	SINGAPORE	6550 8900	LUXEMBOURG	0032 70 23 31 59	UNITED KINGDOM	0345 602 1454
DANMARK DENMARK	44 663 155	SLOVENSKO SLOVAKIA	232 199 930	МАКЕДОНИЈА MACEDONIA	(02) 20 50 319	U.S.A.	800-395-8325
VENEZUELA	0800-7268724						22/12/2015

Date of purchase: / Date d'achat / Fecha de compra / Data da compra / Data d'acquisto / Kaufdatum / Aankoopdatum / Købsdato / Inköpsdatum / Kjøpsdato / Ostovipiv / Data zakupu / Data vnzáriz / Jijizijimo data / Ostokupel / Datum nakupa / Sorozatszám / Dátum nákupu / Pirkama datums / Datum kupnje / Data cumparării / Datum nákupu / Tariik pembelian / Tanggal pembelian / Ngay mua hàng / Satin alama tariih / Дата продажи / Дата на закупована / Датум на купована / Сатисага мөрдөө / Ημερομηνία αγοράς / Κατάσταση αγοράς / 購買日期/購入日/구입일자/ تاريخ الشراء/ تاريخ الشراء/ تاريخ الشراء/ تاريخ الشراء/ تاريخ الشراء/ تاريخ الشراء/ تاريخ الشراء

Product reference: Références du produit / Referencia del producto / Nome do produto / Tipo de produto / Typusnummer des Gerätes / Artikelnummer van het apparaat / Referencomummer / Produktereférens / Artikkelnummer / Tuotenumero / referencia producto / Model / Gaminis numeris / Tostis vicienumber / Tip aprata / Visidrifas kode / Tur yvorku / Produkta atzatuscs numars / Model proizvoda / Oznaka proizvoda / Cod produs / Produkt ruzijank / Referenci produk / Ml sin phám / Úrin koda / Модель / Модель / Модел на уреду / Модел / Κολλεικός προϊόντος / Усталык / 產品編號/產品模型/製品レファレンス番号/產品編號 / مرجع المنتج الشامل / مرجع المنتج الشامل / المرجع المنتج الشامل / المرجع المنتج الشامل

Retailer name and address: / Nom et adresse du vendeur / Nombre y dirección del minorista / Nome e endereço do revendedor / Nome e indirizzo del negozio / Name und Anschrift des Händlers / Naam en adres van de dealer / Forhandler navn & adresse / Aterfürsäljarens namn och adress / Forhandler navn og adresse / Jillettensyjän nimi ja osoite / Nazwa i adres sprzedawcy / Numele și adresa vânzătorului / Parhastotevis pradedimaine i adresses / Mijaja kauplus ja address / Naziv i mesto trgovine / Trupaszán / Název a adresa predajcu / Vekula noozakums un adrese / Naziv i adresa maloprodajce / Naziv i adresa prodajne mjesta / Naziv i adresa vnzáriz / Naziv a adresa prodajnog mjesta / Nome y address vnzáriz / Tip aprata / Visidrifas kode / Tur yvorku / Produkta atzatuscs numars / Model proizvoda / Oznaka proizvoda / Cod produs / Produkt ruzijank / Referenci produk / Ml sin phám / Úrin koda / Модель / Модель / Модел на уреду / Модел / Κολλεικός προϊόντος / Усталык / 產品編號/產品模型/製品レファレンス番号/產品編號 / مرجع المنتج الشامل / المرجع المنتج الشامل / المرجع المنتج الشامل / المرجع المنتج الشامل

Distributor stamp / Cachet distributeur / Sello del distribuidor / Carimbo do revendedor / Timbro del negozio / Händlersstempel / Stempel van de dealer / Forhandler stempe / Aterfürsäljarens stämpel / Forhandler stempe / Jillettensyjän leima / Pieczec sprzedawcy / Stampila vnzáriz / Aitspazdas / Tempel / Žig trgovine / Elbido neve, címé / Razliko predaju / Žinogis / Peat maloprodajce / Peat prodajne mjesta / Stampila vnzáriz / Razliko prodaje / Cap penicil / Cap dar Toko Penjual / Cua hàng bán đóng dúi / Satcs Firmann Kasesi / Peat prodaju / Pezata prodajca / Peat na trgovinski objekt / Peat na prodavnaštata / Сатушынын мөйрү / Στορωγιο κατωστήματος / Κατάσταση λιπίστη / 零售商的蓋印/販売店印/소매점 직인 / تاريخ التوزيع/ تاريخ التوزيع/ تاريخ التوزيع





9100019913-03